

# atech

**Green street furniture for you**

---

2025 issue

**LET'S BRING  
NATURE  
TO THE CITY!**





ATECH has been producing street furniture and planting solutions in France since 1986. We help you create more sustainable, resilient green spaces and cities.

#### **A SPONGE CITY SOLUTION IN THE GROUND**

To address the environmental challenges of today, we offer solutions that include bottomless planters or rain tree kerbs. These systems make it easier for water to infiltrate the soil and contribute to sustainable water resource management.

#### **BRING NATURE INTO BUILT-UP ENVIRONMENTS**

When you cannot plant directly in the ground, raised planters are an effective means of achieving urban greening. However, efficient water management is needed to reduce maintenance costs and water consumption. With our connected systems, we control the wetting and drying cycles for root systems and substrates. We help you optimise water use so you use less and don't water unnecessarily. Our products are suitable for every situation, whether for town squares, streets or roadways, schools, ecodistricts or green belts.

#### **COMPLIANCE WITH THE FRENCH ANTI-WASTE LAW FOR A CIRCULAR ECONOMY LAW (AGEC)**

We are proud to fulfil our obligations under this law by using recycled or reused materials. Our life-cycle analysis (LCA) approach includes repainting and upcycling plant pots, flowerboxes and hanging baskets, which reduces your carbon footprint.

For more than 35 years, we have worked closely with landscape professionals to bring nature back into urban areas. Drawing on the local know-how we honed in Cholet, France, we constantly innovate and work with you.

Let's work together to bring nature into the city.

---

*Thomas Bourgeois-République,*  
ATECH CEO



Together, let's create a sponge city where integrated water management aligns with water cycles.

A vision of plants and greenery in sustainable cities.



**READ ABOUT:**

- our solutions to save and reuse water (see p.22)

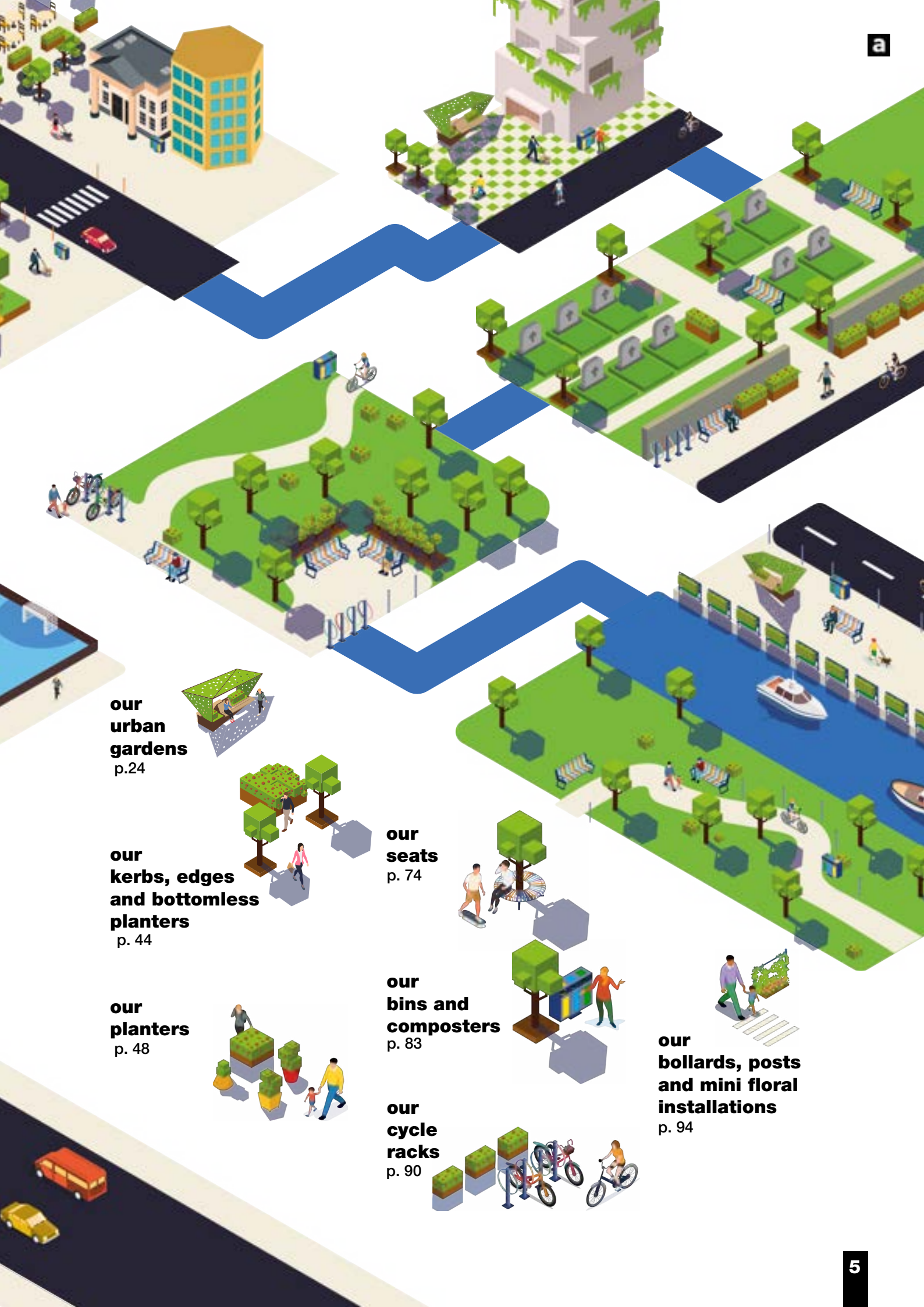

**our urban gardens**  
p.24



**our kerbs, edges and bottomless planters**  
p. 44



**our seats**  
p. 74



**our planters**  
p. 48



**our bins and composters**  
p. 83



**our bollards, posts and mini floral installations**  
p. 94



**our cycle racks**  
p. 90

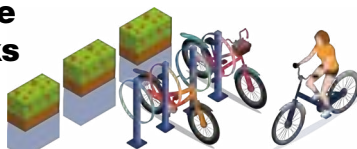



# plant on rooftops



Custom bottomless planters, painted galvanised steel, Ettelbruck (LU)



SEE  
our kerbs  
p. 46

# landscaping for patios



a



Mosaïque picnic table, powder-coated aluminium, Aoste (FR)



Bottomless planters, double return, powder-coated steel, Bourg-la-Reine (FR)



Bespoke kerbs, powder-coated aluminium, Ermont (FR)



SEE  
our kerbs  
p. 46  
and our tree  
base solutions  
p. 45



Tailor-made edges and seats, sandblasted Corten steel, activated and stabilised, and laminate panels, Levallois-Perret (FR)



# energise building entrances



Cléo planter No. 3, powder-coated steel, Paris (FR)



Prisme urban garden, model C, powder-coated steel, and untreated exotic wood slats, Luxembourg City (LU)

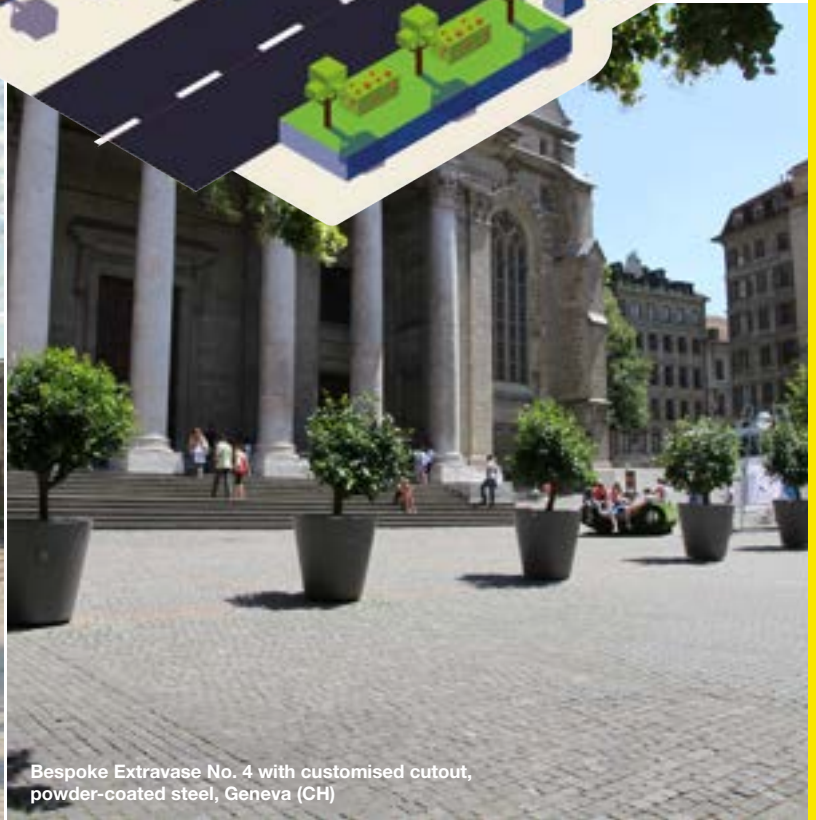

Bespoke Extravase No. 4 with customised cutout, powder-coated steel, Geneva (CH)



8 Bespoke, square bottomless planters, activated and stabilised Corten steel, Belval (LU)



energise  
city & town  
entrances



a

Bespoke arrangement, customised cutouts, activated Corten steel, Béthune (FR)



Bespoke town entrance sign, customised cutouts, activated Corten steel, Le Ménitré (FR)



Bespoke town entrance sign, customised cutouts, activated Corten steel, Sautron (FR)



Round bottomless planters, customised cutouts, sandblasted Corten steel, Audierné (FR)



## plant alongside roadways



Kerbs, powder-coated steel, La Ricamarie (FR)

Bespoke urban gardens, activated Corten steel, sandblasted and stabilised, and treated bamboo slats, Saint Amand Montrond (FR)

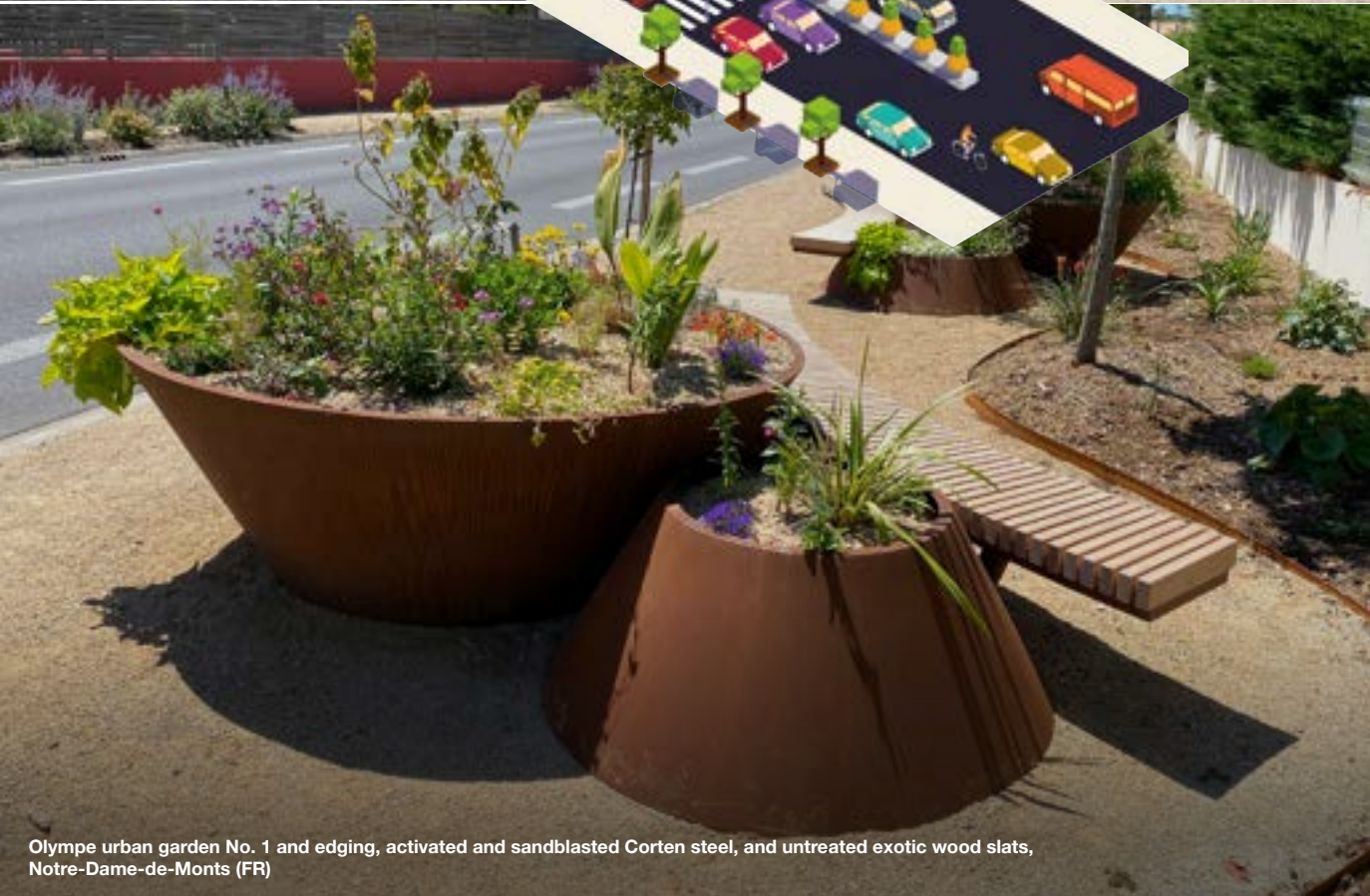

Olympe urban garden No. 1 and edging, activated and sandblasted Corten steel, and untreated exotic wood slats, Notre-Dame-de-Monts (FR)



Kerbs, powder-coated steel, Loudéac (FR)



protect  
pedestrian  
crossings



Custom bottomless planters, painted galvanised steel, La Ricamarie (FR)



## 5-METRE PEDESTRIAN PROTECTIONS

### CHOOSE YOUR LAYOUT

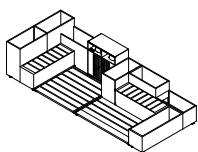

#### 1 URBAN GARDEN

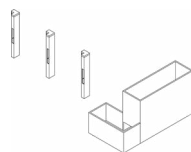

#### 2 SOFT MOBILITY LANE



## PROTECTIONS



Min.: 1 m<sup>2</sup>  
Max.: 2.9 m<sup>2</sup>



#### Materials and finishes:

- Painted aluminium structure
- Seats: Treated bamboo, untreated exotic wood, robinia or larch

#### Attachment:

- Freestanding

#### Option:

- PRM access ramp



Scan the QR code for more information and the technical data sheet



# landscaping for schools



A-LINÉA urban garden, models A and F, powder-coated steel, option: Extravase pots, recyclable plastic, Saint Amand Montrond (FR)



Bespoke bottomless planters with seating, powder-coated aluminium, and untreated wood slats, Chambray-lès-Tours (FR)



C-NATURA urban garden No. 7 with bespoke seating, powder-coated steel, and untreated exotic wood slats, Montmorency (FR)



Bottomless planters, powder-coated aluminium, Chambray-lès-Tours (FR)



A-LINÉA urban garden, model F, powder-coated steel, option:  
Extravase pots, recycled plastic, Barr (FR)



energise  
- ecodistricts  
- greenbelts  
- waterfronts



HEDERA posts, powder-coated steel, Loos (FR)



Olympe urban garden No. 1, powder-coated steel, and untreated exotic wood slats, Henin Beaumont (FR)



Single DUALIS bin, ashtray option



PASTEL bench, powder-coated steel, bespoke colour

SEE  
our bins p. 83  
our barriers,  
bollards and  
posts p. 94



DUALIS PASTEL triple recycling bin, powder-coated steel and stickers, Bréhal (FR)



SQUARE bollard, PRM option, powder-coated steel, Coudekerque-Branche (FR)



Classique planter No. 3, post cap and ball finial option, powder-coated steel, and painted wood panels, Les Sables d'Olonne (FR)



Bespoke kerbs and DUALIS bollard, activated Corten steel, Corneilles-en-Parisis (FR)



Bespoke pergolas, powder-coated steel, Neuilly-sur-Marne (FR)



# planting in and protecting town squares



Urban garden, activated Corten steel and untreated robinia slats, Plélan-le-Grand (FR)



Prisme urban garden, model C, powder-coated steel and untreated exotic wood slats, Luxemburg (LU)



SEE  
our urban  
gardens p. 24



Bespoke kerbs, powder-coated aluminium, Ermont (FR)



Movable bespoke planters, forklift pockets, powder-coated steel



Movable bespoke planters, hydraulic jacks, powder-coated aluminium, Béziers (FR)

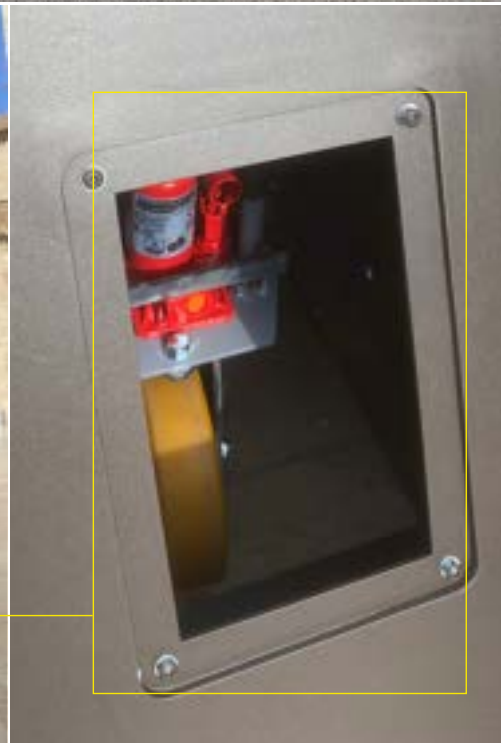

## MOVABLE PLANTERS



Min.: 3 m<sup>2</sup>



- **Materials and finishes:**
  - Painted steel structure
  - Forklift pockets OR hydraulic jacks
- **Attachment:**
  - Freestanding



Scan the QR code for more information and the technical data sheet

# landscaping for cemeteries



PASTEL bench, powder-coated steel, Plomelin (FR)



SYNERGIE cycle racks, Corten steel, activated and stabilised, Viriat (FR)



SEE  
our seats  
p. 74  
our  
cycle racks  
p. 90

Bottomless planters, Corten steel, activated and stabilised, Dammarie-les-Lys (FR)

**landscaping for  
parks**

**a**



C-NATURA bench, option with powder-coated steel armrests and untreated robinia slats, Reims (FR)



Bespoke benches and picnic table, powder-coated steel and varnished teak slats, Durtal (FR)



Bespoke bench, powder-coated steel, and treated bamboo slats, Maulévrier (FR)



SQUARE seats, powder-coated steel



# our solutions to create shade



Cube planter No. 3, FreshCity urban garden, powder-coated steel, Bazas (FR)



Bespoke urban gardens, sandblasted Corten steel, and grooved laminate wood panels, Lisieux (FR)



our solutions  
to facilitate  
the upkeep  
of tree bases



a



Bespoke kerbs, activated Corten steel, Montesson (FR)



Bespoke urban garden, powder-coated aluminium and untreated exotic wood slats, Mornant (FR)



## our solutions to facilitate water management

### HOW CAN YOU REDUCE MAINTENANCE COSTS, HAVE A HIGH-QUALITY LOOK AND SAVE WATER?

Because you can't always plant in the ground itself, planting above ground is another way of bringing nature back to urban areas.

Learn about Tranquileau, a tool you can integrate into **sets of planters**. It checks and determines water needs in the root zone using a soil moisture sensor, which will improve the plant's resilience and ability to thrive on its own.

## water tanks for **planters and pots**:

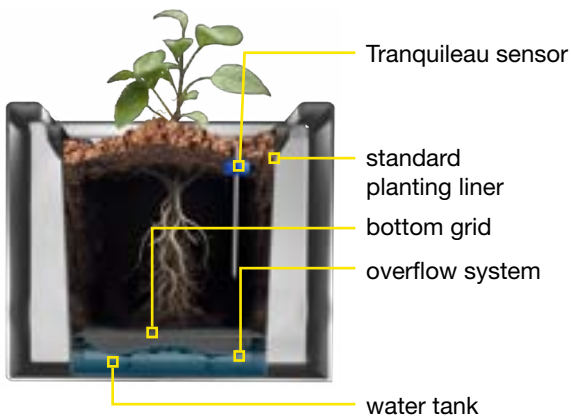

### existing planting liners

- reduce watering frequency
- avoid unnecessary rounds
- save water

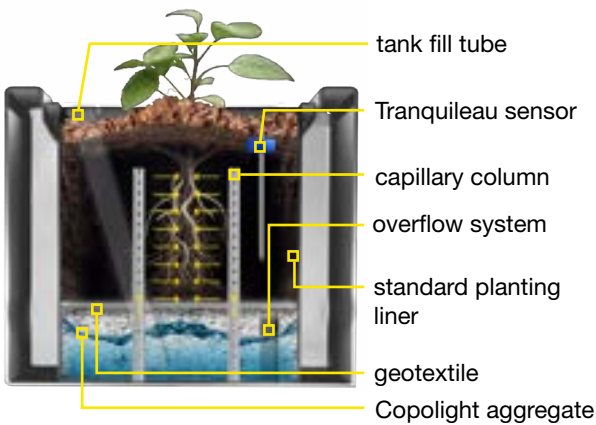

### planting liners with **capillary columns**

- reduce watering frequency
- avoid unnecessary rounds
- save water

💡 **Plants can be changed**

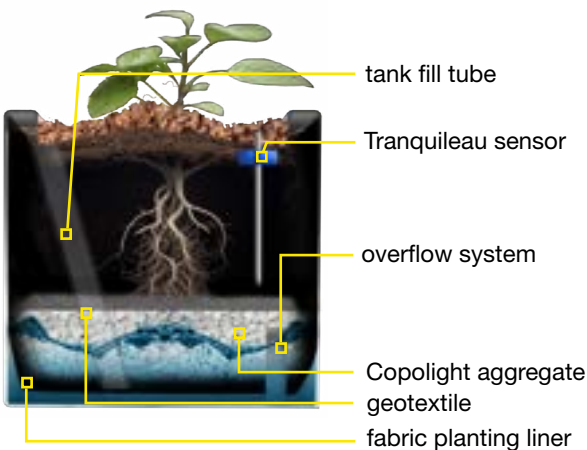

### **garden** planting liners

- reduce watering frequency
- avoid unnecessary rounds
- save water

💡 **More substrate**

## Watering frequency results for planting liner No. 3 – Summer 2024

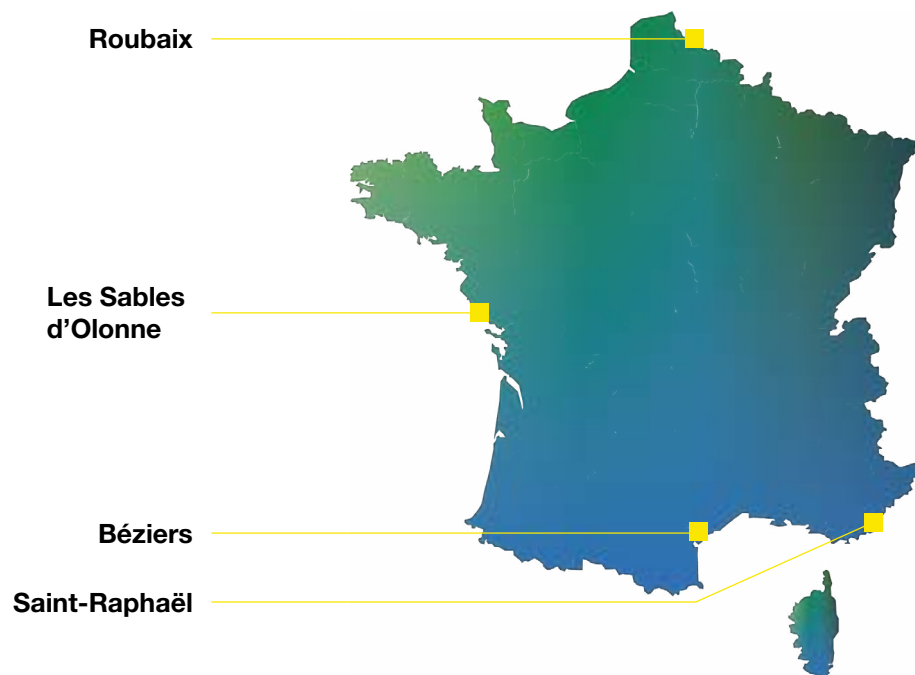

Over the summer and across France, we tested the different water tank options we offer for our planting liners. See the results in the planting liner technical data sheet below.

### Tranquileau system option

Our Tranquileau solution on a set of Dualis planters resulted in **50% less watering.**

### planting liner with **capillary columns** and Tranquileau option

Our Tranquileau solution on a set of Dualis planters resulted in **60% less watering.**

### garden planting liner and Tranquileau option

Our Tranquileau solution on a set of Dualis planters resulted in **70% less watering.**

Scan the QR code for more information and the technical data sheet



## water tank for urban gardens or welded planters

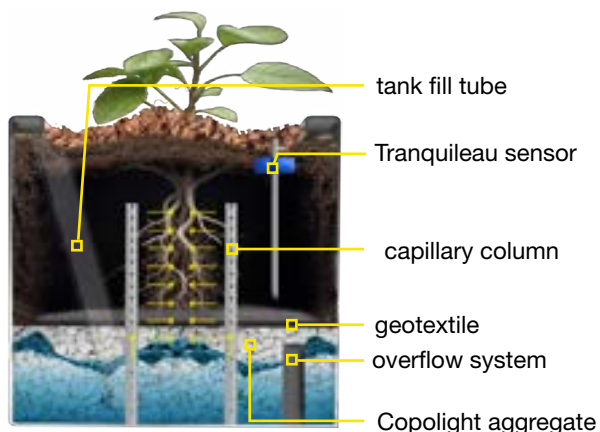



# our urban gardens and shade canopies

## ■ Prisme

URBAN GARDEN  
AND SHADE CANOPY

p. 26

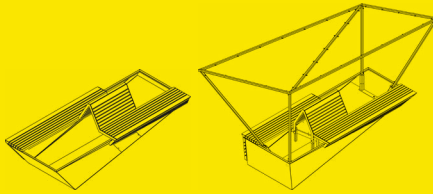

## ■ Olympe

p. 28

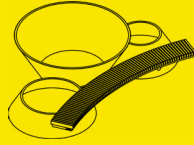

## ■ Contrario

SHADE CANOPY

p. 29



## ■ A-LINÉA

p. 30

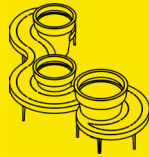

## ■ Edward VII

p. 31

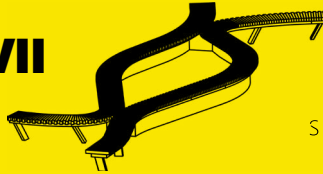

JULIEN  
COUTUREAU  
DESIGN  
STUDIO

## ■ Sustineo

URBAN GARDEN  
AND SHADE CANOPY

p. 38

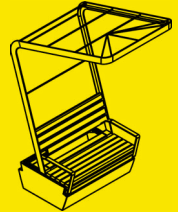

## ■ C-NATURA

p. 32

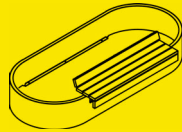

## ■ SQUARE

p. 34

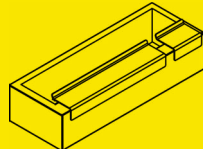

JÉRÔME BOISSIÈRE  
Design studio

## ■ Équinoxe

PERGOLA

p. 40

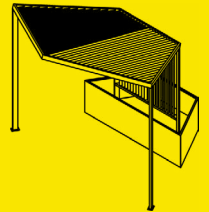

JÉRÔME BOISSIÈRE  
Design studio

## ■ Hélios

PERGOLA

p. 42

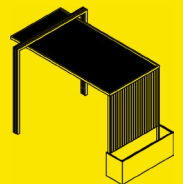



Model C, Luxembourg City (LU)

# Prisme urban garden



Min.: 2.2 m<sup>2</sup>  
Max.: 15.1 m<sup>2</sup>



## Materials and finishes:

- Painted steel structure
- Forklift pockets
- Seat and backrest (see. p. 104):  
Untreated exotic wood or larch

## Options:

- Shelf
- For No. 4 and 5 only, shade provided by:
  - \_ Shade sail for micro-ventilation
  - \_ Stainless steel mesh for dense vegetation
  - \_ Large stainless steel mesh for plants for refreshing shade (upon request)

Scan the QR code for more information and the technical data sheet



## MODULE FOR PLANTERS

1

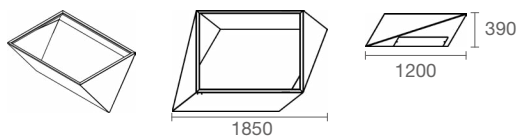

## BACKLESS BENCH MODULES

2

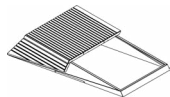

4

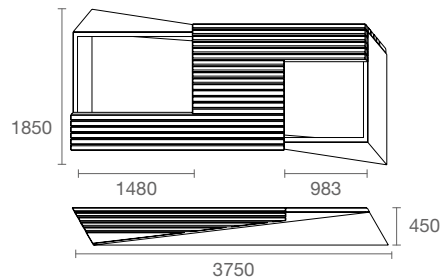
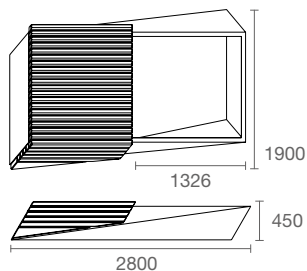
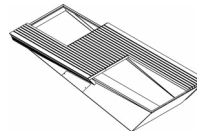

## MODULES - BENCHES

3

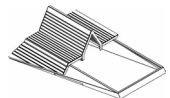

5

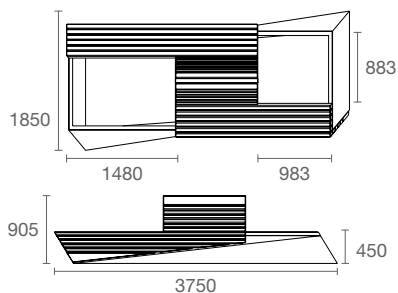
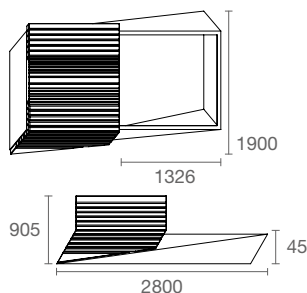
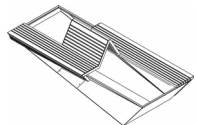



Module No. 5, shade canopy option with stainless steel mesh, Maulévrier (FR)



Module No. 5, shade canopy option with stainless steel mesh  
La Roche-sur-Yon (FR)



Module No. 1, Saint-Genis-Pouilly (FR)

# Olympe

## urban garden



Min.: 5.4 m<sup>2</sup>  
Max.: 12.9 m<sup>2</sup>

### Materials and finishes:

- Painted steel structure
- Seat and backrest (see. p. 104): Treated bamboo, untreated exotic wood, robinia or larch

### Options:

- 'Light' version
- Shelf

Scan the QR code for more information and the technical data sheet



### MODULES - URBAN GARDENS

1

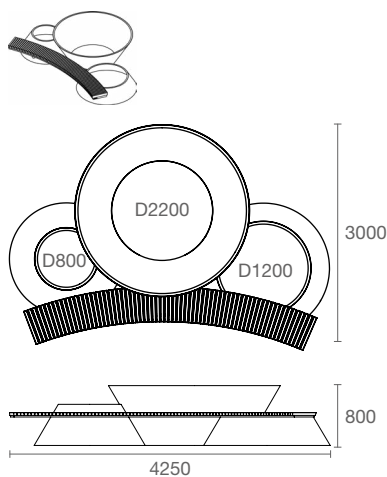

2

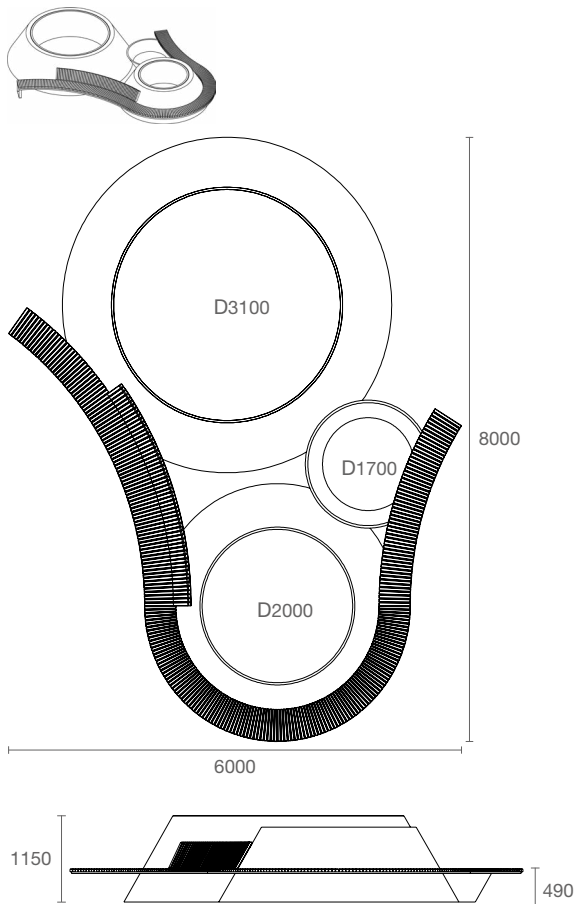



Stainless steel mesh option for dense vegetation

**MODULE - URBAN GARDEN & SHADE CANOPY**

1

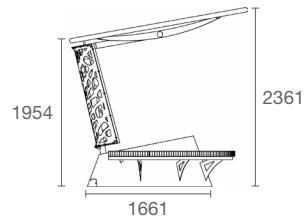
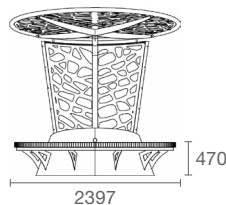
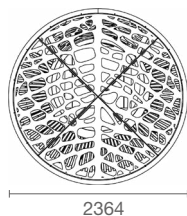

## Contrario urban garden



**Materials and finishes:**

- Painted steel structure
- Shade canopy (sheet metal cutouts)
- Forklift pockets
- Seats (see p. 104):  
Treated bamboo, untreated exotic wood, robinia or larch

**Options:**

- shade sail for micro-ventilation
- stainless steel mesh for dense vegetation
- large stainless steel mesh with climbing plants for refreshing shade (upon request)



Scan the QR code for more information and the technical data sheet



Module No. 1, option: Extravase pot, Nancy (FR)



Bespoke Models E and F, Bressuire (FR)

# A-LINÉA

## urban garden



Min.: 0.5 m<sup>2</sup>  
Max.: 1.8 m<sup>2</sup>



### Materials and finishes:

- Painted steel structure

### Variant:

- Perga planter p. 61

### Option:

- Extravase pot p. 69

Scan the QR code for more information and the technical data sheet



### View the other products in the A-LINÉA range:

- planter p. 66
- backless bench p. 81
- standing seat p. 81
- bin p. 87
- cycle rack p. 91
- barrier p. 100
- bollard p. 100

### CHOOSE YOUR LAYOUT

#### D800 MODULES

1

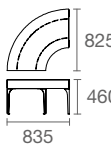

2

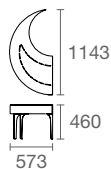

3

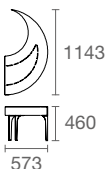

#### D1200 MODULE

7

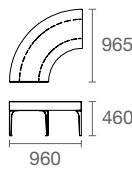

#### D1000 MODULES

4

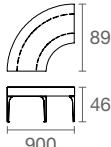

5

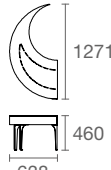

6

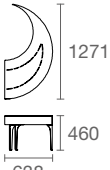

#### MODULE FOR TABLES

8

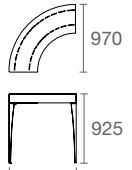

A

2-3  
1150 X 1150

B

5-6  
1280 X 1280

C

4-4-4-4  
1800 X 1800

D

7-7-7-7  
1930 X 1930

E

6-4-4-1-1-3  
2950 X 1735

F

6-4-4-1-1-1-3  
4100 X 2560

G

8-8-8-8  
1800 X 1800

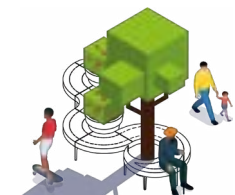



Module No. 1, brushed stainless steel, shelf option, Paris



a

**MODULE - URBAN GARDEN PLANTED IN THE GROUND**

**1**

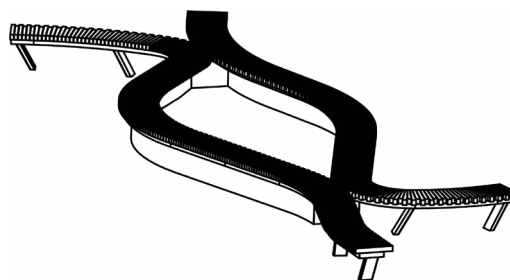
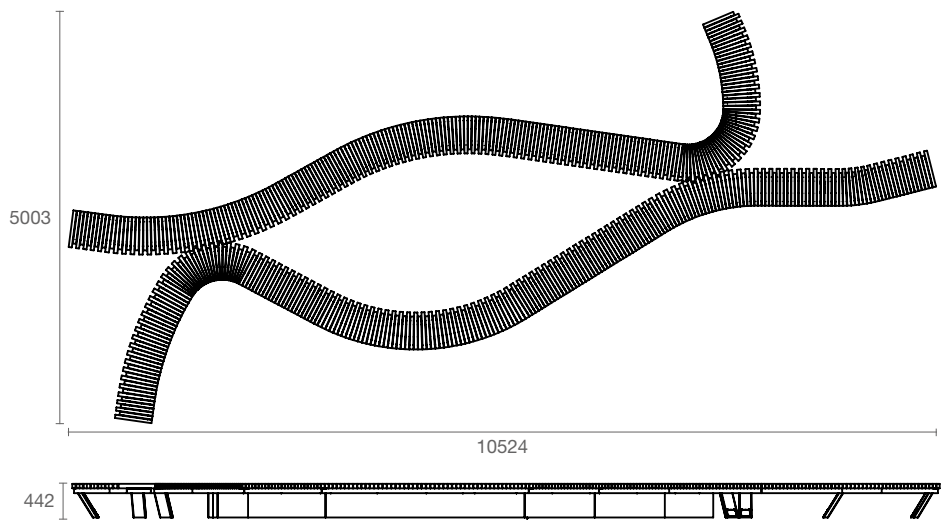

**Edward VII**  
urban garden



20 m<sup>2</sup>

**Materials and finishes:**

- Painted aluminium structure
- In the ground (bottomless)
- Seat (see p. 104): Treated bamboo, untreated exotic wood, robinia or larch

**Option:**

- Shelf



Scan the QR code for more information and the technical data sheet



Module No. 2, activated and stabilised Corten steel, Dammarie-les-Lys (FR)

# C-NATURA

## urban garden

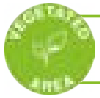

Min.: 3.4 m<sup>2</sup>  
Max.: 8.8 m<sup>2</sup>

### Materials and finishes:

- Painted steel structure
- Bottomless
- Seat and backrest (see p. 104):  
Treated bamboo, untreated exotic wood, robinia or larch

Scan the QR code for more information and the technical data sheet



### View the other products in the C-NATURA range:

- |                  |       |
|------------------|-------|
| - planter        | p. 66 |
| - bench          | p. 80 |
| - backless bench | p. 80 |
| - bin            | p. 88 |
| - cycle rack     | p. 93 |
| - barrier        | p. 99 |
| - bollard        | p. 99 |

### MODULES - OVAL BOTTOMLESS PLANTERS

#### 1 BACKLESS

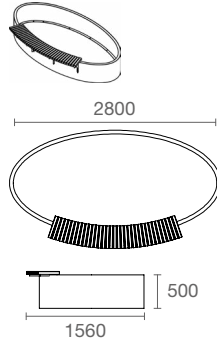

#### 2 WITH BACKREST

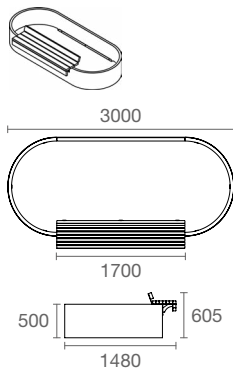

### MODULES - ROUND BOTTOMLESS PLANTERS

#### 3 BACKLESS

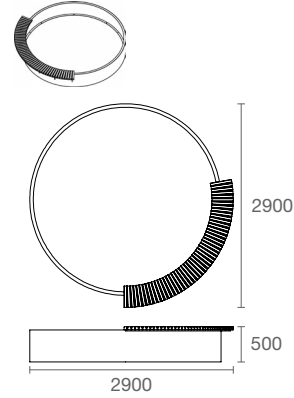

#### 4 BACKLESS

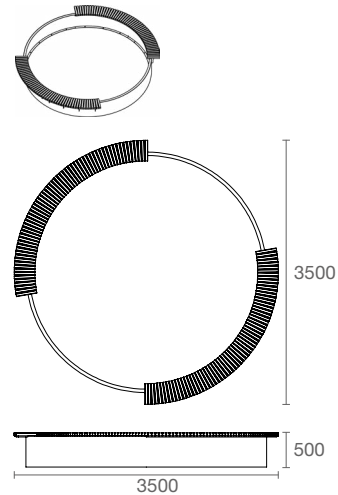



Module No. 8, activated and stabilised Corten steel, untreated exotic wood slats, La Limouzière (FR)

**MODULES - SQUARE  
BOTTOMLESS PLANTERS**

**5 WITH BACKREST**

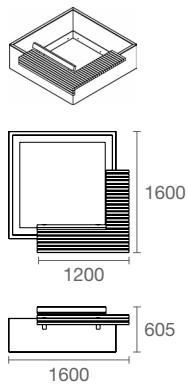

**6 WITH BACKREST**

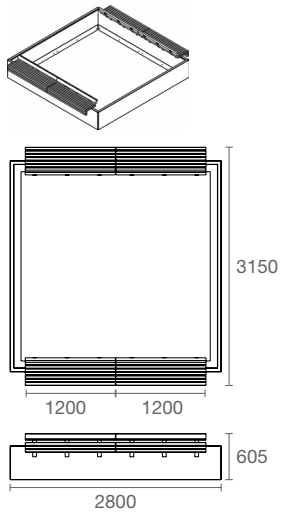

**MODULES - RECTANGULAR  
BOTTOMLESS PLANTERS**

**7 WITH BACKREST**

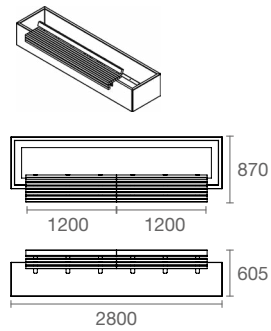

**8 WITH BACKREST**

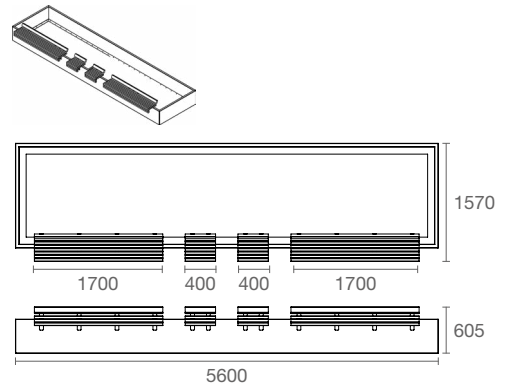



Module No. 2



Module No. 1



3 x modules No. 1, Cholet (FR)

# SQUARE

## urban garden



Min.: 1.8 m<sup>2</sup>  
Max.: 3.8 m<sup>2</sup>



- Materials and finishes:**
- Painted steel seat and structure
  - Adjustable stands
  - Black planting liner, recycled plastic (see p. 67)

- Option:**
- Lifting system

Scan the QR code for more information and the technical data sheet



View the other products in the SQUARE range:

- |                  |        |
|------------------|--------|
| - planter        | p. 64  |
| - bench          | p. 76  |
| - backless bench | p. 76  |
| - seat           | p. 76  |
| - bin            | p. 88  |
| - cycle rack     | p. 93  |
| - barrier        | p. 101 |
| - bollard        | p. 101 |

### MODULES - URBAN GARDENS

1

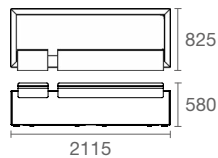
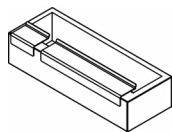

2

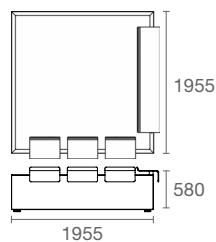
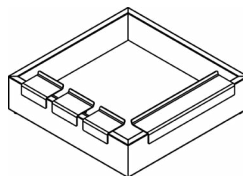



Module No. 1, Bazas (FR)

**MODULE - URBAN GARDEN AND SHADE CANOPY**

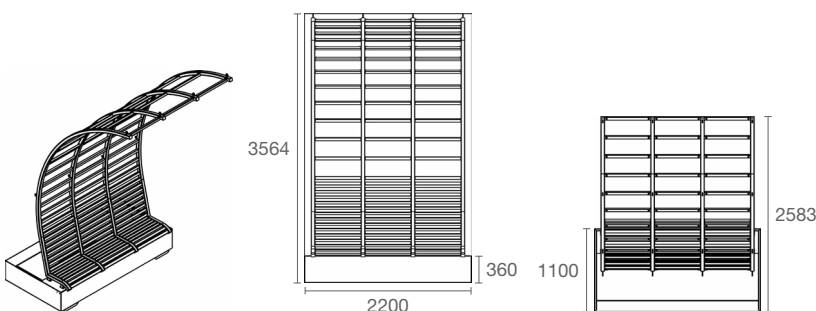

**FreshCity**  
urban garden



9.2 m<sup>2</sup>



Furniture  
obtained from  
reuse

**Materials and finishes:**

- Painted steel structure
- Integrated forklift pockets
- Seat and backrest made of wood from former window frames
- Net for climbing plants

**Option:**

- Adjustable stands



Scan the QR code for  
more information and the  
technical data sheet



Modules No. 4-5-2-8-2-4, Croix (FR)

# Oasis urban garden



**Materials and finishes:**

- Painted steel structure
  - Forklift pockets
  - Adjustable stands
  - Aluminium planting liner
  - Grooved, laminate wood seat
- th. 8 mm, various colours (see p. 104):  
Light Afro, Afro Sahara, English Cherry, Sun Pear

**Option:**

- Lifting system

Scan the QR code  
for more information and  
the technical data sheet



**CHOOSE YOUR LAYOUT**

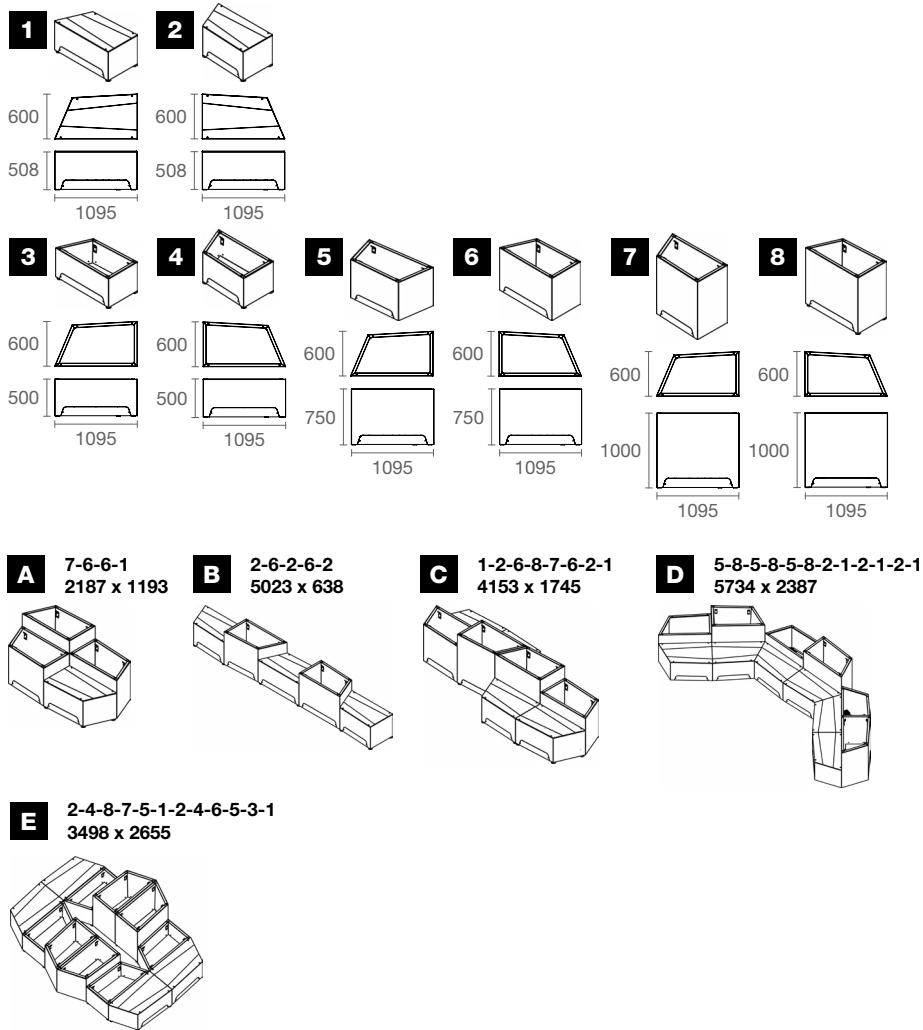



Modules No. 1-1-4-1-5-5-1-1-2-1-3, LED lighting, Puteaux (FR)



Modules No. 1-1-4-1-5-5-1-1-2-1-3, LED lighting, Puteaux (FR)

**CHOOSE YOUR LAYOUT**

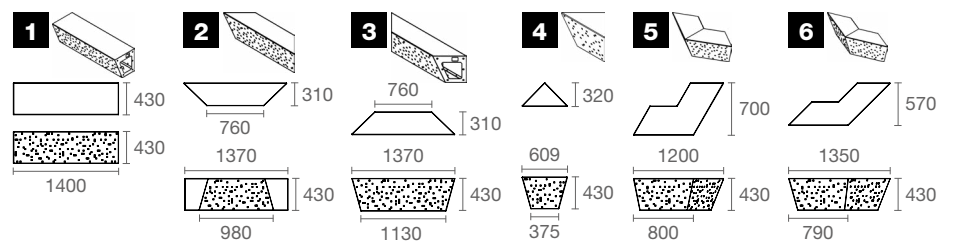

**A** 1-4-1-4-1-4-1-4  
2280 X 2280

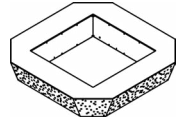

**B** 5-1-5-1-5-1  
2810 X 2810

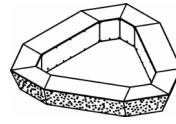

**C** 3-1-4-1-3-1-4-1  
2600 X 3135

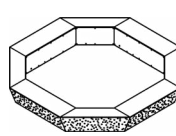

**D** 6-2-6-1-6-2-6-1  
2530 X 3500

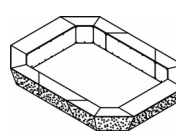

**E** 3-1-3-1-3-1-3-1  
3370 X 3370

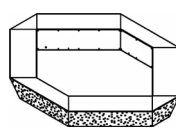

**Mosaïque urban garden**

Min.: 5.2 m<sup>2</sup>  
Max.: 10 m<sup>2</sup>

- Materials and finishes:**
  - Painted aluminium structure
  - In the ground
- Option:**
  - LED lighting

Scan the QR code for more information and the technical data sheet

See the Mosaïque planter p. 56



Module No. 2 customised with logo, Paris (FR)



Module No. 1, Saint Raphaël (FR)

# Sustineo

## urban garden

JULIEN  
COUTUREAU  
DESIGN  
STUDIO



### Materials and finishes:

- Painted steel structure
- Seat and backrest (see p. 104):  
Untreated exotic wood, robinia or larch

### Options:

- Shade canopy
- Panel

Scan the QR code  
for more information  
and the technical data sheet



## MODULES - URBAN GARDENS

### 1 NO OPTIONS

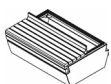

1160



### 2 PANEL OPTION

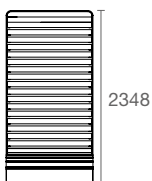
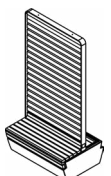

### 3 CANOPY SHADE OPTION

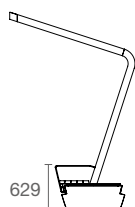
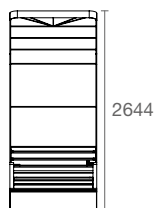
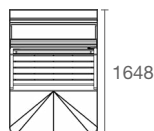
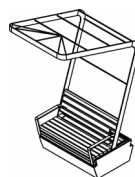





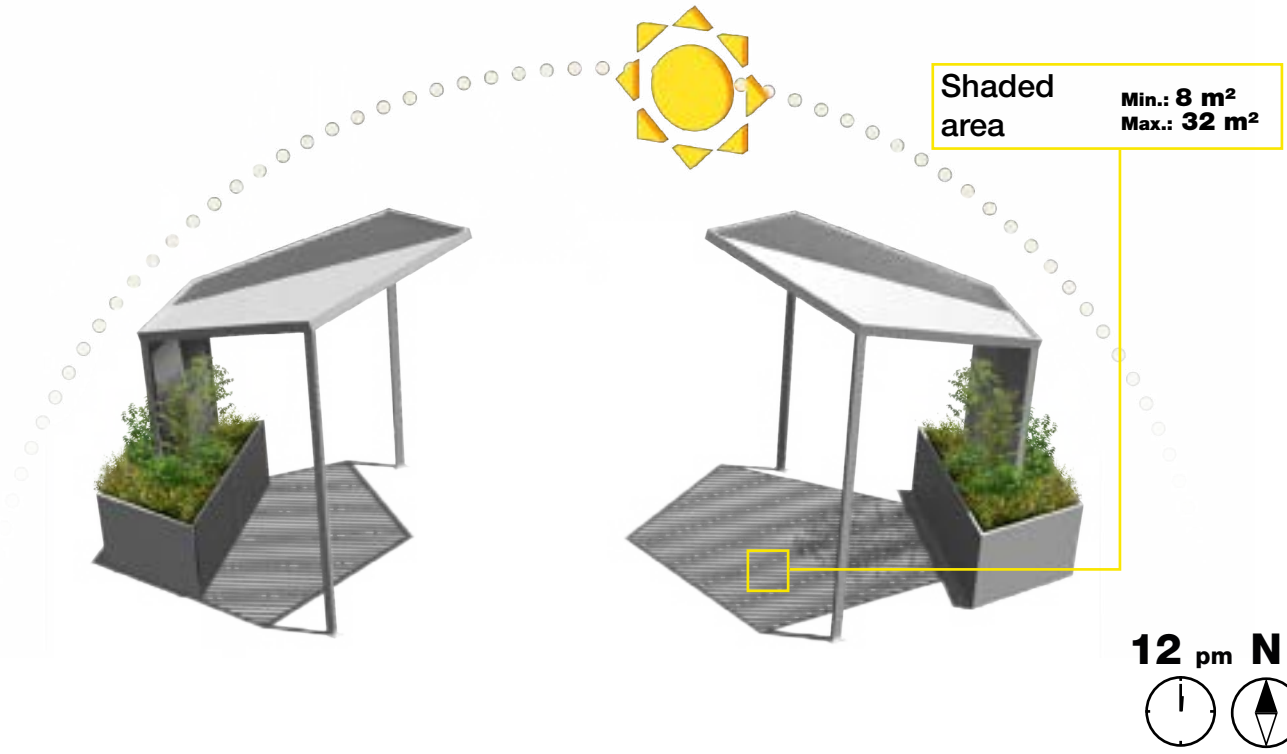

**CHOOSE YOUR LAYOUT**

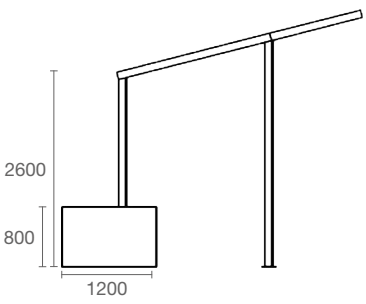
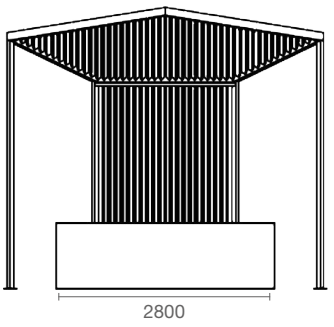
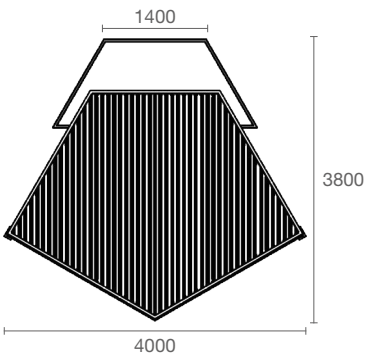

JÉRÔME BOISSIÈRE  
Design studio

**A** 1-1  
7600 x 4000

**B** 1-1  
7600 x 4000

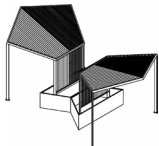

**C** 1-1-1  
7600 x 7600

**D** 1-1-1  
7600 x 7600

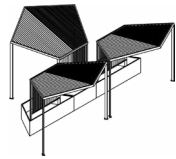
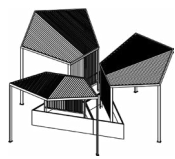

**E** 1-1-1-1  
7600 x 7600

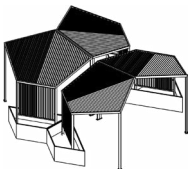

# Equinoxe pergola



Min.: 2.5 m<sup>2</sup>  
Max.: 10 m<sup>2</sup>



- Materials and finishes:**
- Painted aluminium structure
  - Rainwater harvesting system



- Attachment:**
- On base plate or embed in ground
- Option:**
- Seat: Untreated Douglas fir

Scan the QR code for more information and technical data sheet





Shaded area  
 Min.: 4 m<sup>2</sup>  
 Max.: 16 m<sup>2</sup>

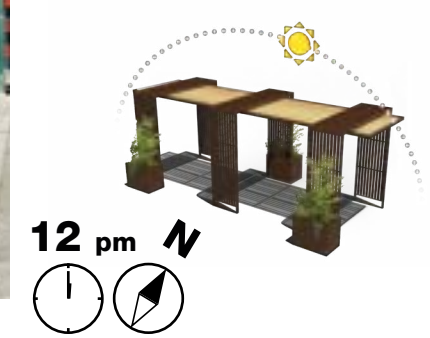

# Hélios pergola

JÉRÔME BOISSIÈRE  
 Design studio

Min.: 1 m<sup>2</sup>  
 Max.: 4.2 m<sup>2</sup>



**Materials and finishes:**

- Painted aluminium structure
- Untreated Douglas fir panel (except No. 1)
- Rainwater harvesting system



**Attachment:**

- On base plate or embed in ground

**Options:**

- Seats and tables

Scan the QR code for more information and the technical data sheet



**MODULES - PERGOLAS**

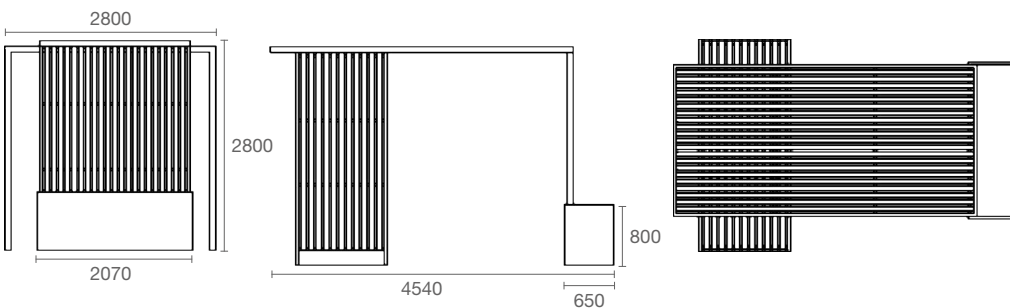
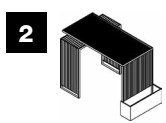
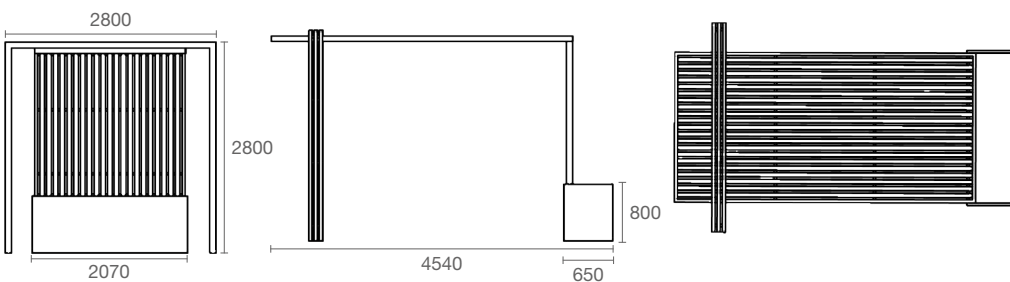
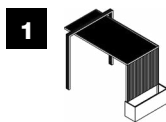

3

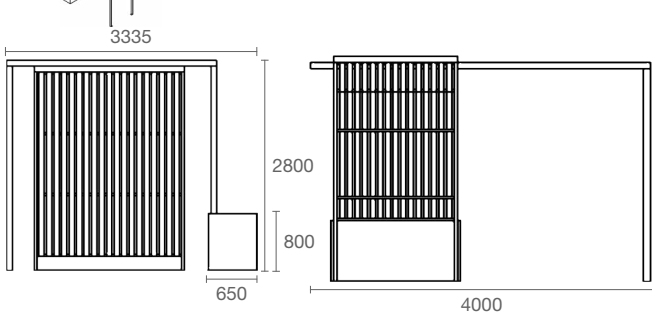

1



4

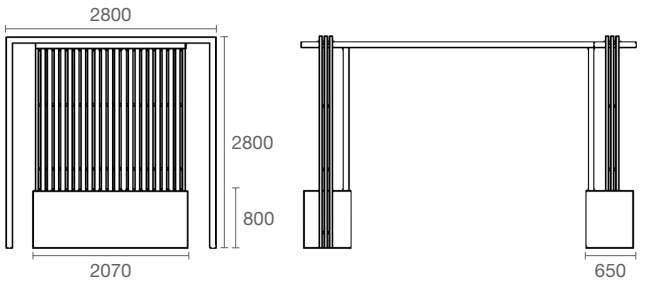
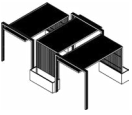

2

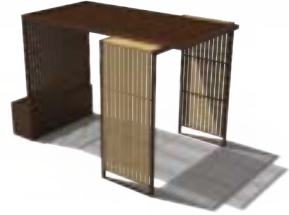

5

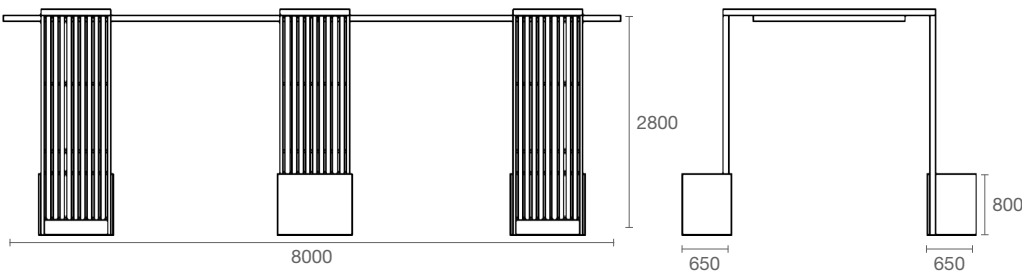
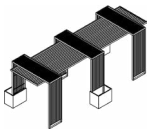

3

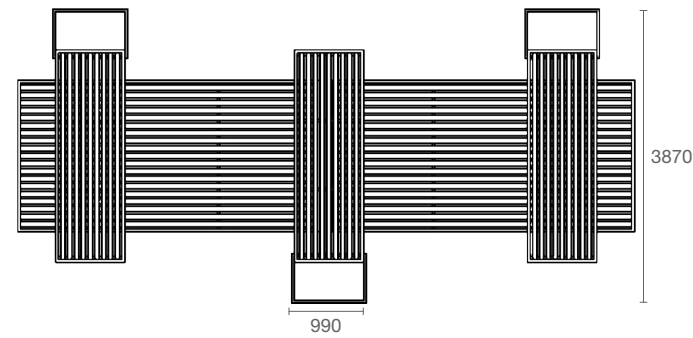

4



5



# our edges, kerbs and bottomless planters: solutions for use in the ground

Bent edging and bottomless planter, untreated Corten steel, Jouy-le-Moutier (FR)

## our straight edges

- 100–300 mm in height
- 2 or 3 LM plates
- assembly: **round head** attachment hardware and stakes (supplied; **welded splices**)
- inner and outer angles (45°, 90° and 135°)

### EXAMPLES OF AVAILABLE ANGLES

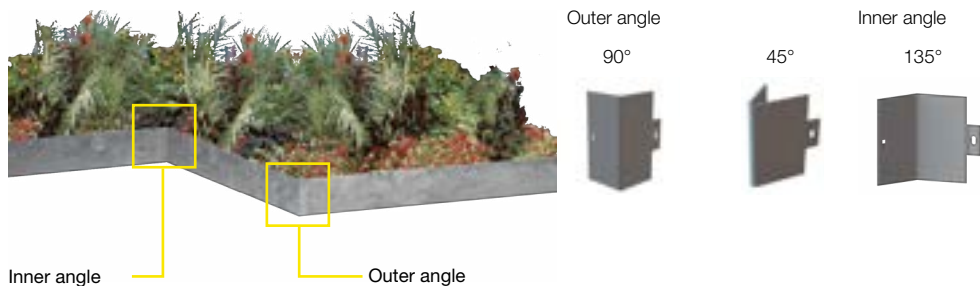

### AVAILABLE MATERIALS



Galvanised steel



Untreated Corten steel (dulls over time to a rust colour)



Untreated aluminium



Contact us for our price list

## our bottomless panel planters

- square, rectangle or round
- thickness: 2–3 mm
- assembly using attachment hardware (supplied)



Scan the QR code to view all our standard dimensions

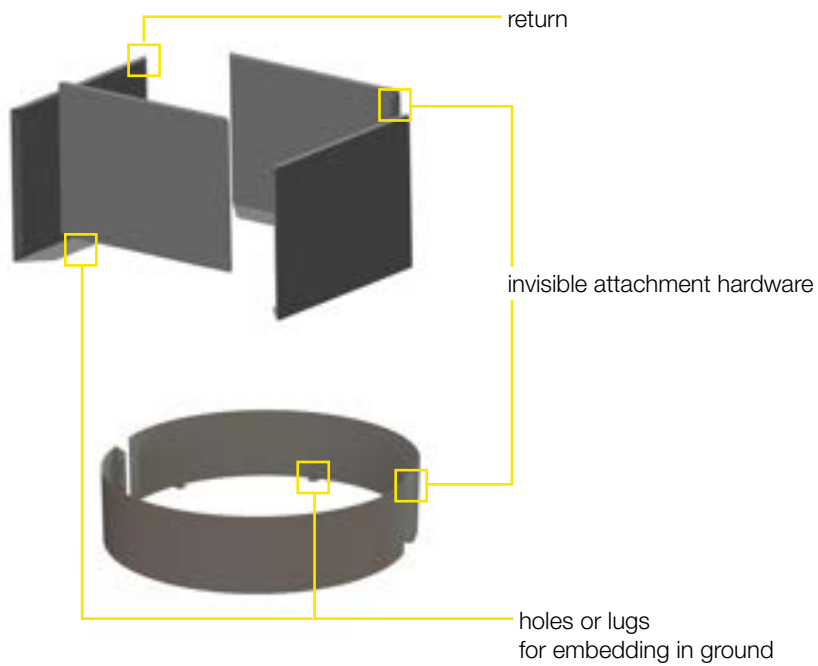

We also offer panel planters with a base (made of painted steel\* and Corten steel) and fully welded planters (painted aluminium\*)



Rectangular bottomless planter, activated Corten steel, Cloyes-sur-le-Loir (FR)

Round bottomless planter, activated Corten steel, Pontoise (FR)



Square and rectangular bottomless planters, activated Corten steel, Chambray-les-Tours (FR)

\*RAL and AkzoNobel colour palettes possible



## our kerbs

- 500 or 1000 mm in height
- assembly using attachment hardware (supplied)
- angles and curves possible

### Options:

- rain tree
- seat (with or without backrest)

### EXAMPLES OF AVAILABLE ANGLES

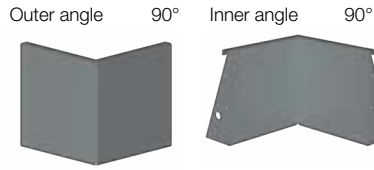

AVAILABLE MATERIALS SEE P. 104 treated bamboo: maximum length = 2000 mm

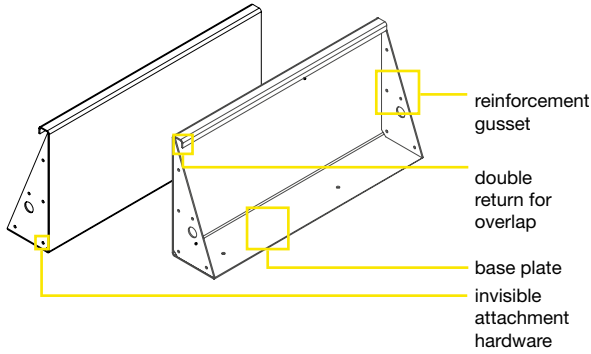

### HARVEST RAINWATER AND REDUCE WATERING WITH KERBS THAT HAVE A RAIN TREE OPTION

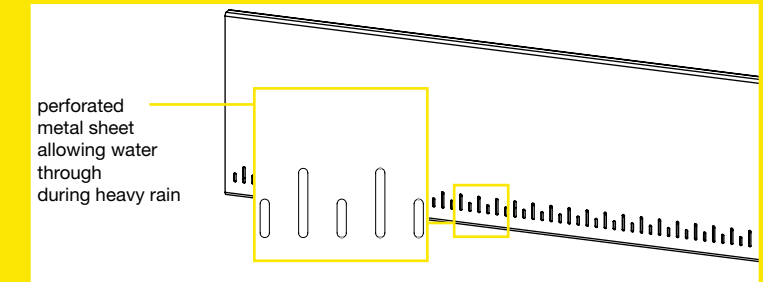

## CONFIGURE YOUR KERB

SEAT POSITION		HEIGHT AND POSITION OF SEATS			
		< 450 mm		> 450 mm	
		slats widthwise	slats lengthwise	slats widthwise	slats lengthwise
Straight kerb	CENTRED invisible gussets				
	TOWARDS FRONT visible gussets				
Rounded kerb	CENTRED invisible gussets				
	TOWARDS FRONT visible gussets				
Kerb angle	CENTRED invisible gussets				
	TOWARDS FRONT visible gussets				

BACKREST OPTION POSSIBLE



Contact us to discuss your project.



Rounded kerb, centred seat (invisible gussets) with slats widthwise, untreated Corten steel, and untreated exotic wood slats, Pornichet (FR)



Straight kerb, centred seat (invisible gussets) with slats widthwise, painted steel, and untreated exotic wood slats, Pau (FR)



Rounded kerb, seat towards front (visible gussets) with slats widthwise, painted steel, and untreated robinia slats, Boudry (CH)



# our planters and water management



# 1. our orangery planters

## ■ our selection

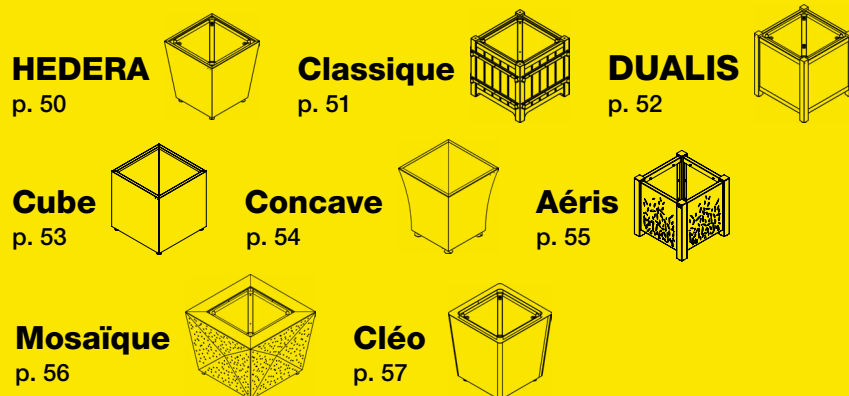

## ■ additional products

p. 58



# 2. our pots and planters

## ■ our selection



## ■ additional products

p. 66

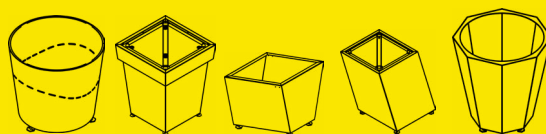

## ■ our selection

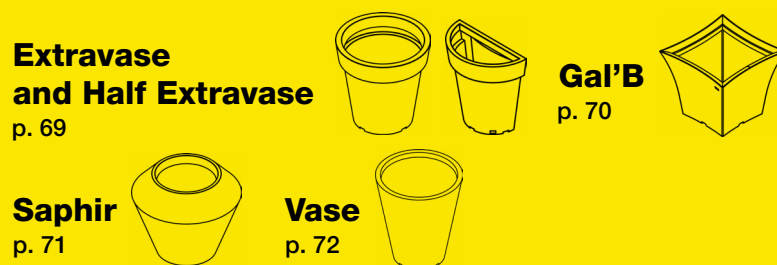

## ■ additional products

p. 73





Stabilised Corten steel, option with integrated pallet jack base, Les Herbiers (FR)

# HEDERA planter



Min.: 0.5 m<sup>2</sup>  
Max.: 1.5 m<sup>2</sup>



## Materials and finishes:

- Painted steel structure
- Adjustable stands
- Black planting liner, recycled plastic (see p. 67)

## Options:

- Integrated pallet jack base (see p. 67)
- Lifting system for planting liner (see p. 67)

Scan the QR code for more information and the technical data sheet



## View the other products in the HEDERA range:

- bench p. 80
- backless bench p. 80
- standing seat p. 80
- bin p. 88
- cycle rack p. 93
- barrier p. 97
- bollard p. 97



1

2

3

4

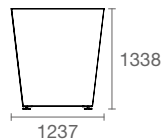
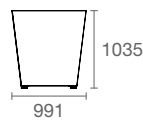
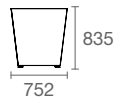

5

6

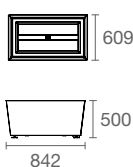



Saint-Barthélémy d'Anjou (FR)



Acorn finial option



Bespoke Classique planter, painted steel, painted wood panels, post cap and ball finial option, Les Sables d'Olonne (FR)

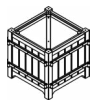

1

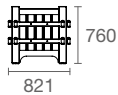

2

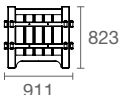

3

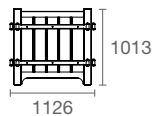

4

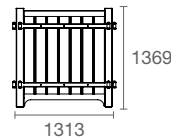

5

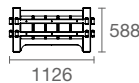

6

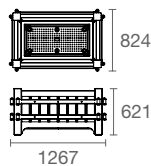

## Classique planter



Min.: 0.7 m<sup>2</sup>  
Max.: 1.9 m<sup>2</sup>



### Materials and finishes:

- Painted steel structure
- Painted aluminium panels
- Adjustable stands
- Black planting liner, recycled plastic (see p. 67)

### Options:

- Ball finial (A), post cap and ball finial (B) or acorn finial (C)
- Lifting system for planting liner (see p. 67)



Scan the QR code for more information and the technical data sheet

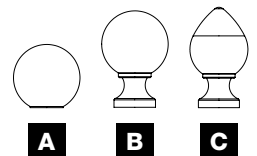



Bent enamelled steel panels, post cap and ball finial option, Lyon (FR)



Smooth steel panels, post cap and ball finial option, Saumur (FR)



Smooth, laminate panels, decorative post cap and ball finial option, Luneville (FR)



Grooved painted steel panels, Douai (FR)



Dark oak stained exotic wood panels, La Tranche-sur-Mer (FR)



Smooth enamelled steel panels, PASTEL range, Bréhal (FR)



Grooved laminate panels, Roscoff (FR)

# DUALIS planter

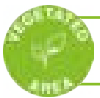

Min.: 0.5 m<sup>2</sup>  
Max.: 1.6 m<sup>2</sup>



## Materials and finishes:

- Painted steel structure
- Panels:
  - \_ Exotic wood (3 wood stains available)
  - \_ Smooth or grooved laminate wood (4 colours available)
  - \_ Smooth or bent painted steel sheet metal
  - \_ Smooth or bent enamelled steel (PASTEL version possible)
- Adjustable stands
- Black planting liner, recycled plastic (see p. 67)

## Options:

- Ball finial (A), post cap and ball finial (B) or acorn finial (C)
- Lifting system for planting liner (see p. 67)

Scan the QR code for more information and the technical data sheet



## View the other products in the DUALIS range:

- bin p. 86
- cycle rack p. 93
- barrier p. 98
- bollard p. 98

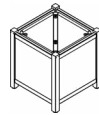
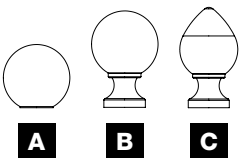

1

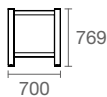

5

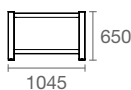

2

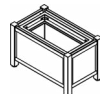
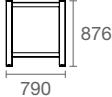

6

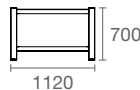

3

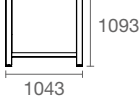

4

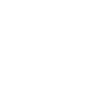

6





Option with integrated pallet jack base, Alençon (FR)



Ailly-sur-Noye (FR)

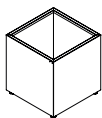

1

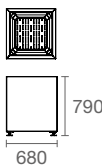

2

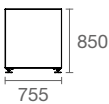

3

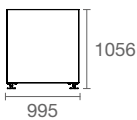

4

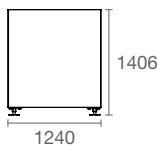

5

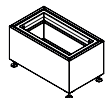

6

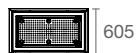

# Cube planter



Min.: 0.5 m<sup>2</sup>  
Max.: 1.5 m<sup>2</sup>



**Materials and finishes:**

- Painted steel structure
- Adjustable stands
- Black planting liner, recycled plastic (see p. 67)

**Options:**

- Integrated pallet jack base (see p. 67)
- Lifting system for planting liner (see p. 67)



Scan the QR code for more information and technical data sheet



Pollestres (FR)



Option with integrated pallet jack base, Brioude (FR)

## Concave planter



Min.: 0.4 m<sup>2</sup>  
Max.: 1.6 m<sup>2</sup>



### Materials and finishes:

- Painted steel structure
- Adjustable stands
- Black planting liner, recycled plastic (see p. 67)

### Options:

- Integrated pallet jack base (see p. 67)
- Lifting system for planting liners (see p. 67)

Scan the QR code for more information and the technical data sheet



1

2

3

4



710

480



821

560



1011

750

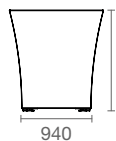

1340

940



Bespoke Aéris planter, round posts, Recquignies (FR)



Option with contrasting sheet metal, Vihiers (FR)

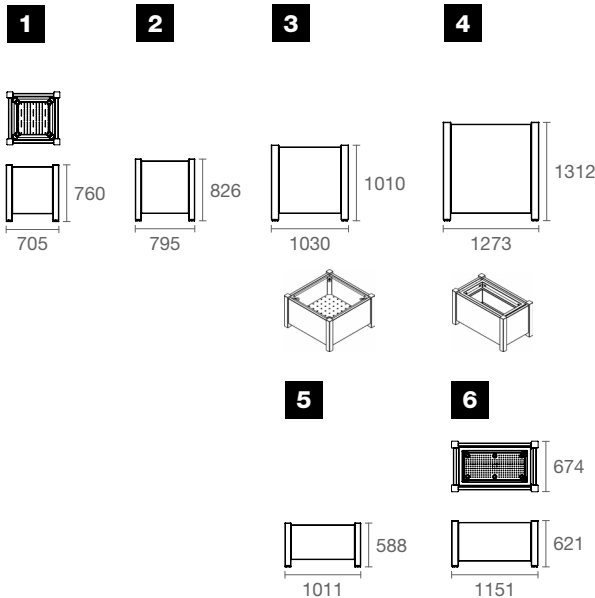
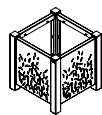

# Aéris planter



Min.: 0.5 m<sup>2</sup>  
Max.: 1.6 m<sup>2</sup>



**Materials and finishes:**

- Painted steel structure
- Painted steel panels, smooth sheet metal with leaf cutout
- Adjustable stands
- Black planting liner, recycled plastic (see p. 67)

**Options:**

- Contrasting sheet metal
- Lifting system for planting liner (see p. 67)



Scan the QR code for more information and technical data sheet



Puteaux (FR)

## Mosaïque planter



Min.: 0.8 m<sup>2</sup>  
Max.: 3 m<sup>2</sup>



### Materials and finishes:

- Painted aluminium structure
- Adjustable stands
- Black planting liner, recycled plastic (see p. 67)

### Options:

- LED lighting
- Lifting system for planting liner (see p. 67)

Scan the QR code for more information and technical data sheet



View the other products in the Mosaïque range:

- urban garden

p. 37



1

2

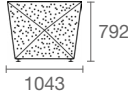
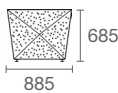

3

4

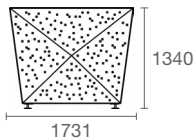
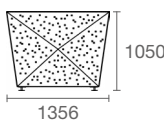



Cléo No. 3, integrated pallet jack base option, customised cutout with contrasting sheet metal, Morestel (FR)



1

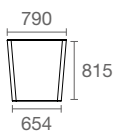

2

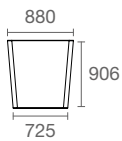

3

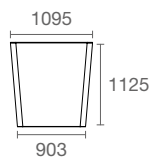

4

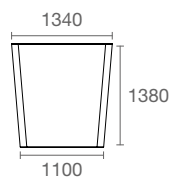

## Cléo planter



Min.: 0.6 m<sup>2</sup>  
Max.: 1.8 m<sup>2</sup>



### Materials and finishes:

- Painted steel structure
- Adjustable stands
- Black planting liner, recycled plastic (see p. 67)

### Options:

- Integrated pallet jack base (see p. 67)
- Lifting system for planting liner (see p. 67)



Scan the QR code  
for more information  
and the technical data sheet



## Asyma planter



### Materials and finishes:

- Painted steel structure
- Panels (see. p. 104): Smooth or grooved laminate wood (4 colours available)
- Adjustable stands
- Black planting liner, recycled plastic (see p. 67)

### Option:

- Lifting system for planting liner (see p. 67)



Scan the QR code for more information and the technical data sheet



## SYNERGIE planter



### Materials and finishes:

- Painted steel structure
- Adjustable stands
- Black planting liner, recycled plastic (see p. 67)

### Options: (see p. 67)

- Integrated pallet jack base
- Lifting system for planting liners



Scan the QR code for more information and the technical data sheet



## Kesa planter

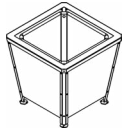

### Materials and finishes:

- Painted steel structure
- Panels (see p. 104): Smooth or grooved laminate wood, painted steel sheet metal
- Adjustable stands
- Black planting liner, recycled plastic (see p. 67)

### Option:

- Lifting system for planting liner (see p. 67)



Scan the QR code for more information and the technical data sheet



## ORIGAMI planter

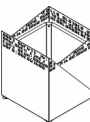

### Materials and finishes:

- Painted aluminium structure
- Adjustable stands
- Black planting liner, recycled plastic (see p. 67)

### Options: (see p. 67)

- Integrated pallet jack base
- Lifting system for planting liners



Scan the QR code for more information and technical data sheet



## Pyrrou planter

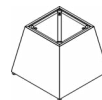

### Materials and finishes:

- Painted steel structure
- Adjustable stands
- Black planting liner, recycled plastic (see p. 67)

### Options: (see p. 67)

- Integrated pallet jack base
- Lifting system for planting liners



Scan the QR code for more information and technical data sheet





# our pots and planters

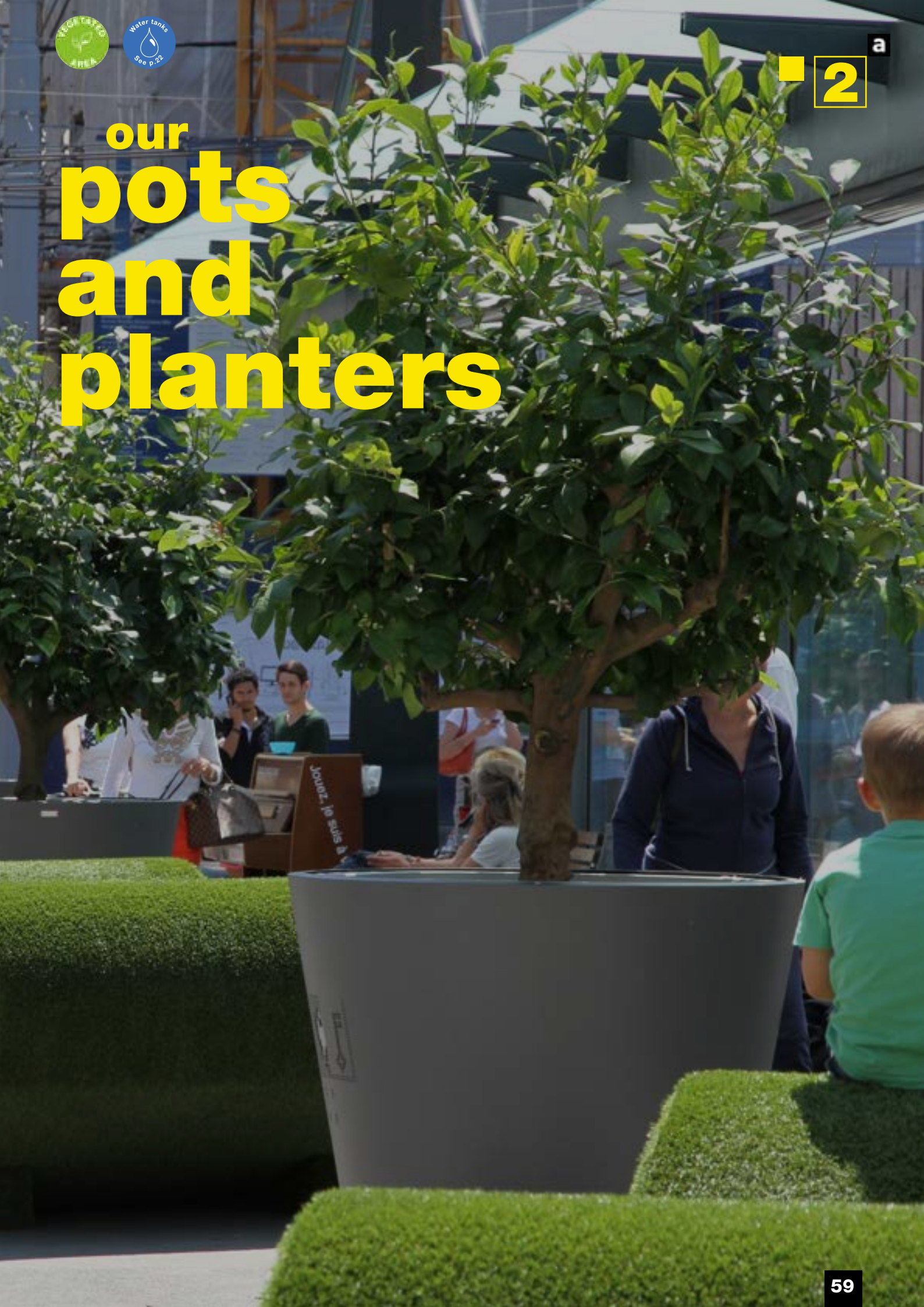



Bespoke Extrabac planter with customised cutout, Geneva (CH)

## Extrabac planter



Min.: 0.4 m<sup>2</sup>  
Max.: 1.8 m<sup>2</sup>



### Materials and finishes:

- Painted steel structure
- Adjustable stands
- Black Extravase planting liner, recycled plastic (see p. 67)

### Options:

- Movable with pallet jack (No. 1 and 2); integrated pallet jack base (No. 3, 4 and 5)
- Lifting system for planting liner (see p. 67)

Scan the QR code for more information and technical data sheet



1

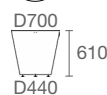

2

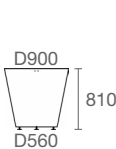

3

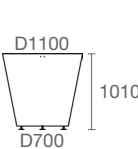

4

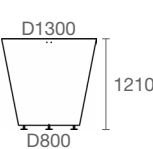

5

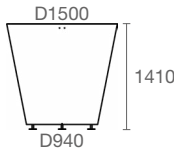



Bressuire (FR)



Dole (FR)



Joué-les-Tours (FR)

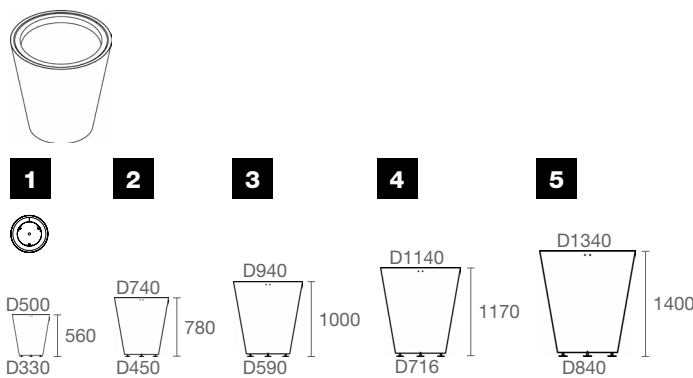

## Perga planter



Min.: 0.2 m<sup>2</sup>  
Max.: 1.4 m<sup>2</sup>



### Materials and finishes:

- Painted steel structure
- Adjustable stands
- Black Vase planting liner, recycled plastic, excl. No. 1 (see p. 67)

### Options:

- Movable with pallet jack (No. 1, 2 and 3); integrated pallet jack base (No. 4 and 5)
- Lifting system for planting liner (see p. 67)



Scan the QR code for more information and technical data sheet



## PASTEL planter



Min.: 0.3 m<sup>2</sup>  
Max.: 1.5 m<sup>2</sup>



### Materials and finishes:

- Painted steel structure (see colours p. 104)
- Adjustable stands
- Extravase pot (see p. 69)

### Options:

- Integrated pallet jack base (see p. 67)
- Lifting system for planting liner (see p. 67)

Scan the QR code  
for more information and  
technical data sheet



### View the other products in the PASTEL range:

- |                  |       |
|------------------|-------|
| - bench          | p. 77 |
| - backless bench | p. 77 |
| - chair          | p. 77 |
| - table          | p. 77 |
| - bin            | p. 87 |
| - cycle rack     | p. 92 |
| - barrier        | p. 98 |
| - bollard        | p. 98 |



1



2

3

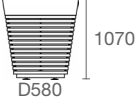
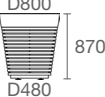
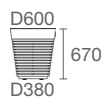

4

5

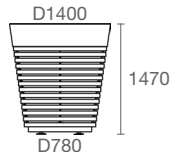
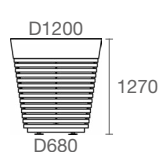



Lancy (CH)



Integrated pallet jack base option, Pornichet (FR)

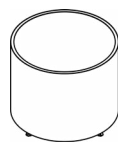

1

2

3

4

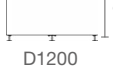
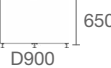

## Patine planter



Min.: 0,4 m<sup>2</sup>  
Max.: 1,5 m<sup>2</sup>

- Materials and finishes:
  - Painted steel structure
  - Adjustable stands

- Options:
  - Integrated pallet jack base (see p. 67)
  - Water tank



Scan the QR code for more information and the technical data sheet



Aurons (FR)

# SQUARE planter



Min.: 0.9 m<sup>2</sup>  
Max.: 1.5 m<sup>2</sup>

## Materials and finishes:

- Painted steel structure

## Options:

- Lifting system
- Water tank

Scan the QR code for more information and technical data sheet



## View the other products in the SQUARE range:

- urban garden p. 34
- bench p. 76
- backless bench p. 76
- seat p. 76
- bin p. 88
- cycle rack p. 93
- barrier p. 101
- bollard p. 101

### HALF BOWL



1

2

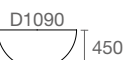

### BOWL



3

4

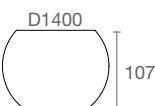
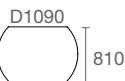

### BEVELLED BOWL



5

6

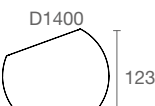
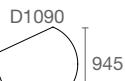



Activated and stabilised Corten steel, integrated pallet jack base option



Seating option, Saint-Genis-Pouilly (FR)

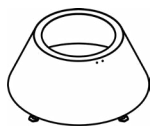

1



D700  
D1100 | 470

2

D800  
D1300 | 670

3

D940  
D1500 | 870

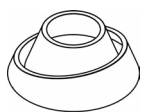

4

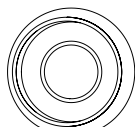

D800  
D1700 | 670

5

D940  
D1900 | 870

6

D1200  
D2350 | 1000

## Contrario planter



Min.: 0.4 m<sup>2</sup>  
Max.: 2.8 m<sup>2</sup>



### Materials and finishes:

- Painted steel structure
- Adjustable stands

### Options:

- Integrated pallet jack base (No. 1, 2 and 3 only) or forklift pockets (No. 4, 5 and 6 only)
- Seats (No. 2, 3, 5 and 6 only)



Scan the QR code for more information and technical data sheet



0.3 m<sup>2</sup> to 1.5 m<sup>2</sup>

## A-LINÉA planter



### Materials and finishes:

- Painted steel structure
- Adjustable stands
- Extravase pot (see p. 69)

### Options: (see p. 67)

- Movable with pallet jack
- Lifting system for planting liners



Scan the QR code for more information and technical data sheet



0.5 m<sup>2</sup> to 1.6 m<sup>2</sup>

## Atempo planter



### Materials and finishes:

- Painted steel structure
- Adjustable stands
- Planting liner, recycled plastic (see opposite)

### Options: (see p. 67)

- Movable with pallet jack
- Lifting system for planting liners



Scan the QR code for more information and technical data sheet



0.5 m<sup>2</sup> to 0.6 m<sup>2</sup>

## C-NATURA planter



### Materials and finishes:

- Painted steel structure
- Adjustable stands

### Options:

- Bottomless
- Movable with pallet jack (see p. 67)



Scan the QR code for more information and technical data sheet



0.7 to 1.4 m<sup>2</sup>

## Eole planter

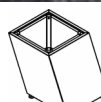

### Materials and finishes:

- Painted steel structure
- Adjustable stands
- Planting liner, recycled plastic (see opposite)

### Options: (see p. 67)

- Movable with pallet jack
- Lifting system for planting liners



Scan the QR code for more information and the technical data sheet



0.2 m<sup>2</sup> to 1.4 m<sup>2</sup>

## Octogone planter



### Materials and finishes:

- Painted steel structure
- Adjustable stands
- Vase planting liner, recycled plastic excl. No. 1 (see opposite)

### Options: (see p. 67)

- Movable with pallet jack
- Lifting system for planting liners



Scan the QR code for more information and the technical data sheet

# Options for planting liners

■ Standard planting liner  
black, recycled plastic



■ Vase planting liner  
black, recycled plastic



■ Extravase planting liner  
black, recycled plastic



## LIFTING SYSTEM



- Hooks for lifting

1 2 3 5



- Lugs for lifting

1 2 3



- Lugs for lifting

2 3 4



- Sling structure with hooks for lifting

4



- Sling structure with hooks for lifting

4



- Reinforcement with lugs for lifting

5 6



- Lugs for lifting

6

■ Make handling easier



- Movable with pallet jack:  
addition of stand covers (removable)



- Integrated pallet jack base



- Forklift pockets

# Options for pots

	 Planting liner	 Handling via pallet jack	 Hooks/lugs for lifting	 Hoisting clamp for forklift trucks	 Anti-tip base plate
 EXTRAVASE				✓	✓
 HALF EXTRAVASE					✓
 GAL'B	✓	✓			✓
 SAPHIR			✓		✓
 VASE				✓	✓
 AMPHOR	✓				✓
 PILA					✓
 RECTILIGNE			✓		✓

 Furniture made with recycled materials



Champagné (FR)



Aimargues (FR)

**EXTRAVASE**

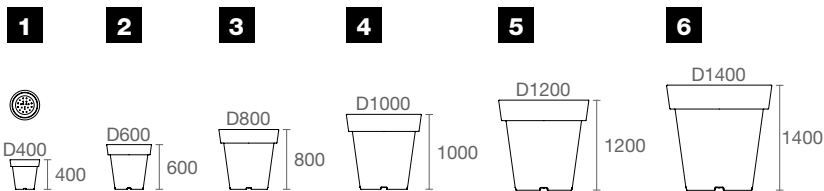

**HALF EXTRAVASE**

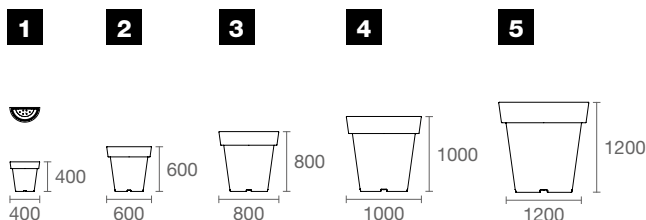

**Extravase and Half Extravase pots**



Min.: 0.1 m<sup>2</sup>  
Max.: 1.5 m<sup>2</sup>



**Materials and finishes:**

- Recyclable PE, 16 colours available (see p. 104)

**Options:**

- Anti-tip base plate (see opposite)
- Hoisting clamp (see opposite)



Scan the QR code for more information and the technical data sheet



Lillers (FR)



Dole (FR)



## Gal'B pot

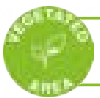

Min.: 0.9 m<sup>2</sup>  
Max.: 1.3 m<sup>2</sup>



### Materials and finishes:

- Recyclable PE,  
16 colours available (see p. 104)

### Options: (see p. 67)

- Movable with pallet jack
- Anti-tip base plate
- Planting liner, recycled plastic

Scan the QR code for  
more information and the  
technical data sheet

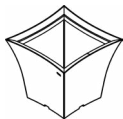

1



2

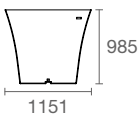
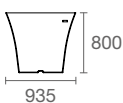



a

Kirchberg (LU)



Saint-Gildas-de-Rhuys (FR)



1

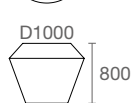

2

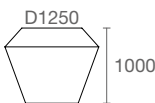

3

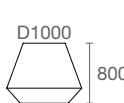

4

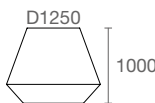

## Saphir pot



Min.: 0.2 m<sup>2</sup>  
Max.: 0.4 m<sup>2</sup>



### Materials and finishes:

- Recyclable PE, 16 colours available (see p. 104)

### Options: (see p. 67)

- Anti-tip base plate
- Hooks for lifting



Scan the QR code for more information and technical data sheet



Monnaie (FR)



Monnaie (FR)



Fontanil-Cornillon (FR)

## Vase pot



Min.: 0.3 m<sup>2</sup>  
Max.: 1.2 m<sup>2</sup>



**Materials and finishes:**  
- Recyclable PE,  
16 colours available (see p. 104)

**Options:** (see p. 67)  
- Anti-tip base plate  
- Hoisting clamp

Scan the QR code  
for more information  
and the technical data sheet



1



2

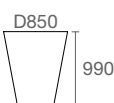

3



4

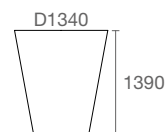



0.2 m<sup>2</sup> to 0.3 m<sup>2</sup>

## Amphor pot



### Materials and finishes:

- Recyclable PE, 16 colours available (see p. 104)

### Options: (see p. 67)

- Anti-tip base plate
- Black planting liner, recycled plastic



Scan the QR code for more information and technical data sheet



0.1 m<sup>2</sup> to 0.3 m<sup>2</sup>

## Pila pot



### Materials and finishes:

- Recyclable PE, 16 colours available (see p. 104)

### Option: (see p. 67)

- Anti-tip base plate



Scan the QR code for more information and technical data sheet



0.5 m<sup>2</sup>

## Quadri pot

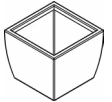

### Materials and finishes:

- Recyclable PE, 16 colours available (see p. 104)



Scan the QR code for more information and technical data sheet



Vernaison (FR)



0.5 m<sup>2</sup>

## Rectiligne pot

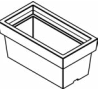

### Materials and finishes:

- Recyclable PE, 16 colours available (see p. 104)

### Options: (see p. 67)

- Anti-tip base plate
- Lugs for lifting



Scan the QR code for more information and the technical data sheet

our  
**seats  
and tables**  
to enjoy  
the shade



**SQUARE**

p. 76

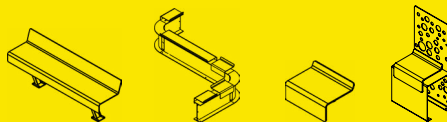
**PASTEL**

p. 77

**SYNERGIE**

p. 78

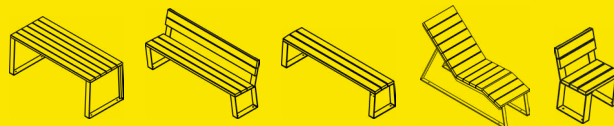
**C-NATURA**

p. 80

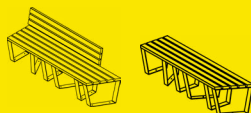
**HEDERA**

p. 80

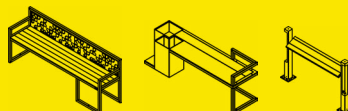
**A-LINÉA**

p. 81

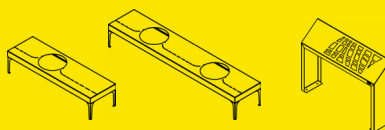
**ORIGAMI**

p. 82

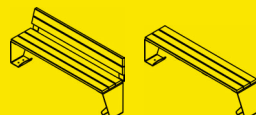



La Chapelle-Heulin (FR)

## bench

- **Materials and finishes:**
  - Painted steel structure



Scan the QR code for more information and technical data sheet

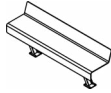

## backless bench

- **Materials and finishes:**
  - Painted steel structure



Scan the QR code for more information and technical data sheet

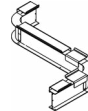

Rochefort (FR)

## seat

- **Materials and finishes:**
  - Painted steel structure
- **Option:**
  - With or without backrest



Scan the QR code for more information and the technical data sheet

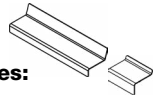

# SQUARE

range



## chair

- **Materials and finishes:**
  - Painted steel structure



Scan the QR code for more information and technical data sheet

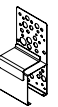

### View the other products in the SQUARE range:

- urban garden p. 34
- planter p. 64
- bin p. 88
- cycle rack p. 93
- barrier p. 101
- bollard p. 101

# PASTEL

range



Rochefort (FR)



Saint-Georges-de-Didonne (FR)

## bench

### Materials and finishes:

- Painted steel structure



Scan the QR code for more information and technical data sheet



Parigné l'Évêque (FR)

## backless bench

### Materials and finishes:

- Painted steel structure



Scan the QR code for more information and technical data sheet

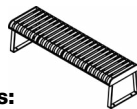

Châteauneuf-sur-Sarthe (FR)

## backless circular bench

### Materials and finishes:

- Painted steel structure

### Option:

- Amphor flower pot (see p. 73)



Scan the QR code for more information and technical data sheet



## chair

### Materials and finishes:

- Painted steel structure



Scan the QR code for more information and technical data sheet



Vivonne (FR)

## tables

### Materials and finishes:

- Painted steel structure



Scan the QR code for more information and technical data sheet

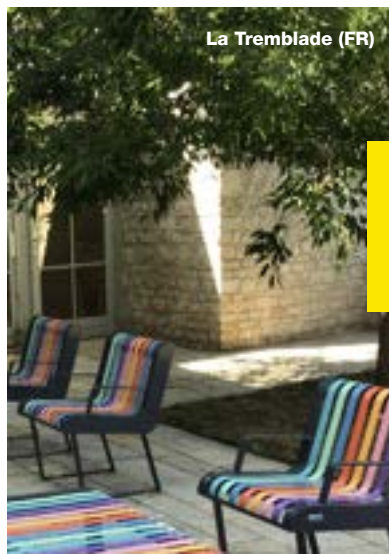
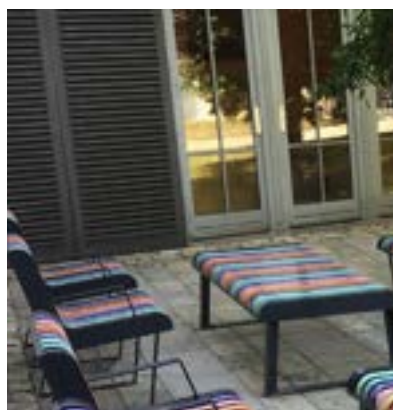
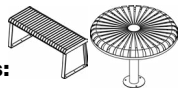

La Tremblade (FR)

View the other products in the PASTEL range: (for colours see p. 104)

- planter p. 62
- bin p. 87
- cycle rack p. 92
- barrier p. 98
- bollard p. 98



Furniture made with recycled materials



Mornant (FR)

## bench

### Materials and finishes:

- Painted steel structure
- Seat and backrest (see. p. 104): Treated bamboo, untreated exotic wood, robinia or larch, Recycled plastic

### Option:

- Armrests



Scan the QR code for more information and technical data sheet

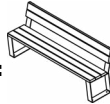

# SYNERGIE

## range

View the other products in the SYNERGIE range:

- planter p. 58
- bin p. 85
- cycle rack p. 93
- barrier p. 96
- bollard p. 96

Belval (LU)

## backless bench

### Materials and finishes:

- Painted steel structure
- Seat (see. p. 104): Treated bamboo, untreated exotic wood, robinia or larch, recycled plastic



Scan the QR code for more information and technical data sheet

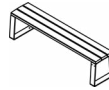

Wallonia (BE)



Teloché (FR)

## Table

### Materials and finishes:

- Painted steel structure
- Table top (see. p. 104): Treated bamboo, untreated exotic wood, robinia or larch, recycled plastic



Scan the QR code for more information and technical data sheet

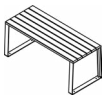

## chair

### Materials and finishes:

- Painted steel structure
- Seat and backrest (see. p. 104): Treated bamboo, untreated exotic wood, robinia or larch, recycled plastic

### Option:

- Armrests



Scan the QR code for more information and technical data sheet



## sun lounger

### Materials and finishes:

- Painted steel structure
- Seat (see. p. 104): Treated bamboo, untreated exotic wood, robinia or larch, recycled plastic



Scan the QR code for more information and technical data sheet



# choose your seats

Straight, curved, arc, rounded: create your model. Then choose the material for your seat (see p. 104): Treated bamboo, untreated exotic wood, robinia or larch.

**1** Straight module with backrest

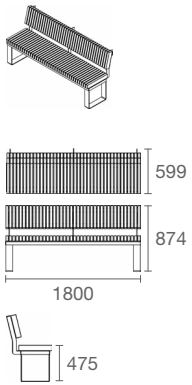

**2** Straight module, backless

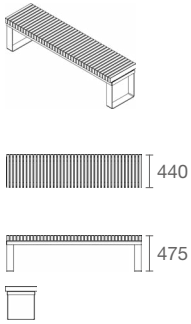

**3** Curved module

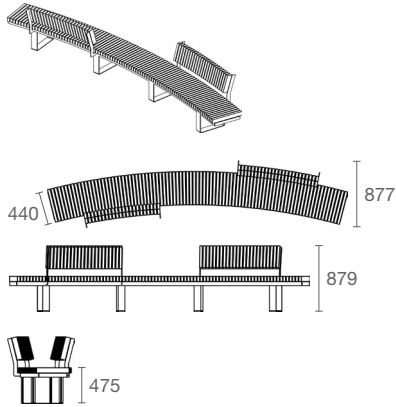

**4** Rounded module

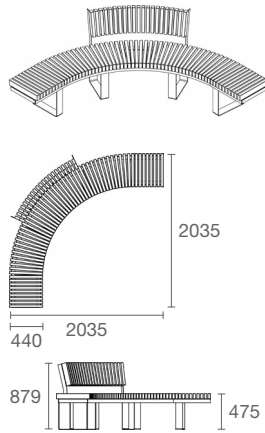

**5** Half-circle module

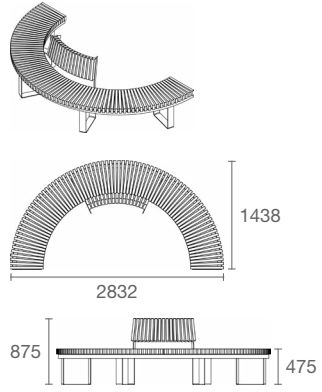

**A** 5-5  
5224 x 2877 x H875

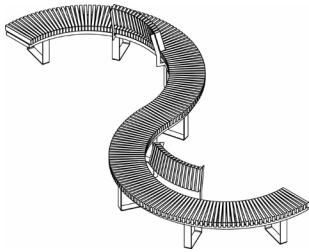

**B** 1-4-1  
3994 x 3994 x h874

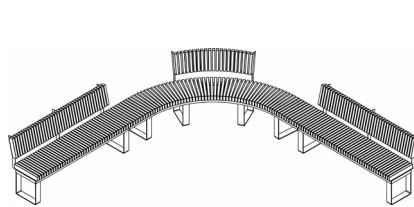

**C** 5-1-5-1  
4677 x 2832 x H875

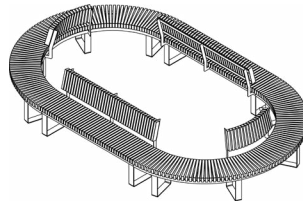

**D** 3-3  
7923 x 1246 x h879

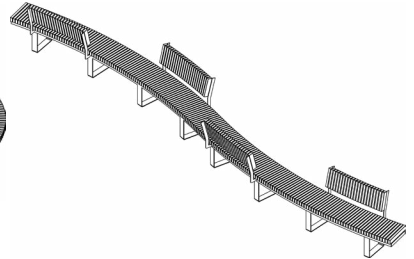

modular  
**SEATS**

# C-NATURA

## range

View the other products in the C-NATURA range:

- urban garden p. 32
- planter p. 66
- bin p. 88
- cycle rack p. 93
- barrier p. 99
- bollard p. 99



Variant with straight edges, Mont-sous-Vaudrey (FR)

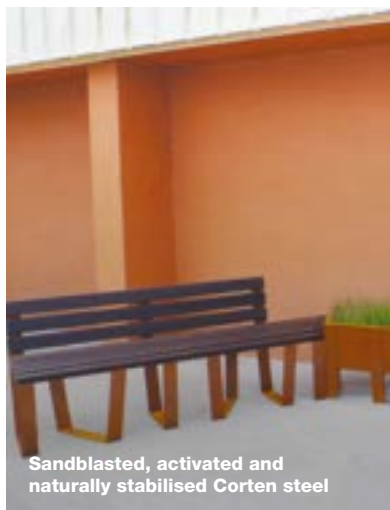

Sandblasted, activated and naturally stabilised Corten steel

### bench

#### Materials and finishes:

- Painted steel structure
- Seat and backrest (see. p. 104): Treated bamboo, untreated exotic wood, robinia or larch

#### Option:

- Armrests



Scan the QR code for more information and technical data sheet



Stabilised Corten steel, Villeneuve-sur-Yonne (FR)

### backless bench

#### Materials and finishes:

- Painted steel structure
- Seat (see. p. 104): Treated bamboo, untreated exotic wood, robinia or larch



Scan the QR code for more information and technical data sheet



# HEDERA

## range

View the other products in the HEDERA range:

- planter p. 50
- bin p. 88
- cycle rack p. 93
- barrier p. 97
- bollard p. 97



Moissy Cramayel (FR)



Dammartin-en-Goële (FR)

### bench

#### Materials and finishes:

- Painted steel structure
- Grooved laminate wood seat th. 8 mm, various colours (see p. 104): Light Afro, Afro Sahara, English Cherry, Sun Pear



Scan the QR code for more information and technical data sheet



### standing seat

#### Materials and finishes:

- Painted steel structure
- Grooved laminate wood seat th. 8 mm, various colours (see p. 104): Light Afro, Afro Sahara, English Cherry, Sun Pear



Scan the QR code for more information and technical data sheet

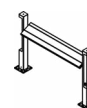

### backless bench

#### Materials and finishes:

- Painted steel structure
- Grooved laminate wood seat th. 8 mm, various colours (see p. 104): Light Afro, Afro Sahara, English Cherry, Sun Pear



Scan the QR code for more information and technical data sheet

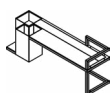



0.1 m<sup>2</sup>

### single pot backless bench

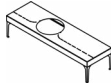

■ **Materials and finishes:**

- Painted steel structure

■ **Option:**

- Extravase pot (see p. 69)



Scan the QR code for more information and the technical data sheet



0.3 m<sup>2</sup>

### double pot backless bench

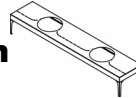

■ **Materials and finishes:**

- Painted steel structure

■ **Option:**

- Extravase pot (see p. 69)



Scan the QR code for more information and the technical data sheet



a

### standing seat



■ **Materials and finishes:**

- Painted steel structure



Scan the QR code for more information and the technical data sheet



# A-LINÉA

range



Aoste (FR)



**View the other products in the A-LINÉA range:**

- urban garden p. 30
- planter p. 66
- bin p. 87
- cycle rack p. 91
- barrier p. 100
- bollard p. 100



Dole (FR)

# ORIGAMI

## range

View the other products  
in the ORIGAMI range:

- planter p. 58
- bin p. 88
- cycle rack p. 93
- barrier p. 100
- bollard p. 100



Saint-Priest-en-Jarez (FR)



### bench

■ **Materials and finishes:**

- Painted steel structure
- Seat and backrest (see. p. 104):  
Treated bamboo, untreated exotic  
wood, robinia or larch

■ **Option:**

- Armrests



Scan the QR code  
for more information and  
technical data sheet

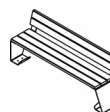

### backless bench

■ **Materials and finishes:**

- Painted steel structure
- Seat (see. p. 104):  
Treated bamboo, untreated exotic  
wood, robinia or larch



Scan the QR code  
for more information and  
technical data sheet

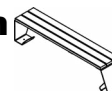

our  
**bins and  
composters**  
for recycling



## ■ our selection

### SYNERGIE

p. 85



### DUALIS

p. 86

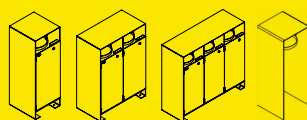

### A-LINÉA

p. 87



### PASTEL

p. 87



## ■ additional products p. 88

### C-NATURA



### HEDERA



### ORIGAMI

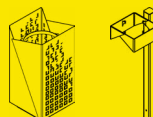

### SQUARE

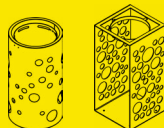

JÉRÔME BOISSIÈRE  
design studio

### Idylle composter

p. 89



Ashtray that is easy to clean manually, developed with the Angers Loire Métropole cleaning services.



Ashtray compatible with all types of bins (example above)



Notre-Dame-de-Monts (FR)

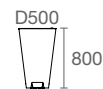

## SYNERGIE bin

### Materials and finishes:

- Painted steel structure
- Waste bag holder

### Attachment:

- Embed in ground with concrete anchors

### Options:

- 0.2 l ashtray, easy to clean manually
- Rain cover



Scan the QR code for more information and technical data sheet

### View the other products in the SYNERGIE range:

- planter p. 58
- bench p. 78
- backless bench p. 78
- chair p. 78
- table p. 78
- sun lounger p. 78
- cycle rack p. 93
- barrier p. 96
- bollard p. 96



Castelnaud-de-Médoc (FR)



Les Grèves (FR)



Two colour bin on raised base plate, Bréhal (FR)

## DUALIS recycling bin

### Materials and finishes:

- Painted steel structure
- Waste bag holder

### Attachment:

- Embed in ground with concrete anchors or install on raised base plate

### Option:

- 0.4 l ashtray, easy to clean manually



Scan the QR code for more information and the technical data sheet

### View the other products in the DUALIS range:

- planter p. 52
- cycle rack p. 93
- barrier p. 98
- bollard p. 98

1

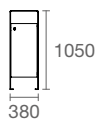
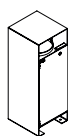

2

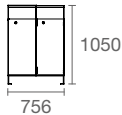
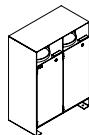

3

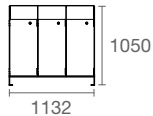
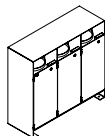

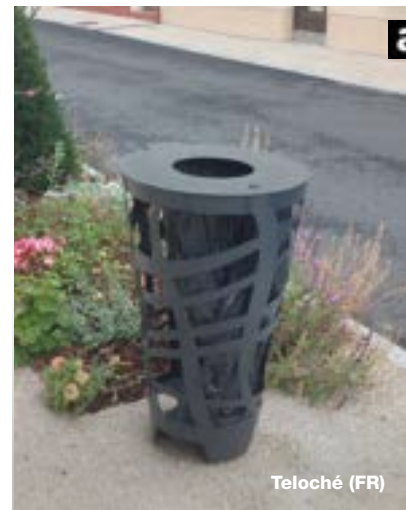

Teloché (FR)

## A-LINÉA bin

### Materials and finishes:

- Painted steel structure
- Waste bag holder

### Attachment:

- Embed in ground with concrete anchors

### Options:

- **0.4 l ashtray**, easy to clean manually
- Rain cover



D510  
800  
D300

### View the other products in the A-LINÉA range:

- urban gardens p. 30
- planter p. 66
- bench p. 81
- backless bench p. 81
- standing seat p. 81
- cycle rack p. 91
- barrier p. 100
- bollard p. 100



Scan the QR code for more information and technical data sheet



Ashtray that is easy to clean manually, developed together with the Angers Loire Métropole cleaning services.

Ashtray compatible with all types of bins (example above)

## PASTEL bin

### Materials and finishes:

- Painted steel structure
- Large format: inner container

### Attachment:

- Embed in ground with concrete anchors

### Options:

- **0.2 l ashtray**, easy to clean manually
- Rain cover



D640  
913  
D400  
1  
D610  
749  
D400  
2



Scan the QR code for more information and technical data sheet



Bespoke colours, Fiers (FR)

### View the other products in the PASTEL range (for colours see p. 104):

- planter p. 62
- bench p. 77
- backless bench p. 77
- circular bench p. 77
- chair p. 77
- table p. 77
- cycle rack p. 92
- barrier p. 98
- bollard p. 98





Claix (FR)

## C-NATURA bin

CLEAR SECURITY BIN

### Materials and finishes:

- Painted steel structure
- Waste bag holder

### Attachment:

- Embed in ground with concrete anchors



Scan the QR code for more information and the technical data sheet

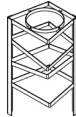

## HEDERA bin

### Materials and finishes:

- Painted steel structure
- Waste bag holder
- Stainless steel wire for plant support

### Attachment:

- Embed in ground with concrete anchors

### Option:

- 0.4 l ashtray, easy to clean manually



Scan the QR code for more information and the technical data sheet



## ORIGAMI bin

### Materials and finishes:

- Painted steel structure
- Waste bag holder

### Attachment:

- Embed in ground with concrete anchors



Scan the QR code for more information and the technical data sheet

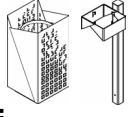

Customised cutouts  
rain cover option, Viriat (FR)

## SQUARE bin

### Materials and finishes:

- Painted steel structure
- Waste bag holder

### Attachment:

- Embed in ground with concrete anchors

### Option:

- Rain cover



Scan the QR code for more information and the technical data sheet

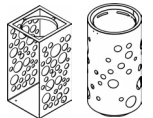



## IDYLLE

# composter



5 m<sup>2</sup>



Furniture obtained from reuse

**Materials and finishes:**

- Painted aluminium structure
- Wood slats taken from former window frames

**Attachment:**

- Freestanding



Scan the QR code for more information and the technical data sheet

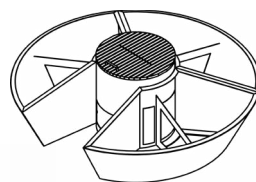

D2281

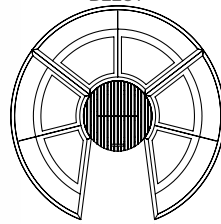

980

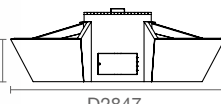

597

D2847



# our cycle racks for soft mobility

## our selection

### A-LINÉA

p. 91



### PASTEL

p. 92



## additional products p. 93

### C-NATURA



### DUALIS



### HEDERA



### ORIGAMI



### SYNERGIE



### SQUARE

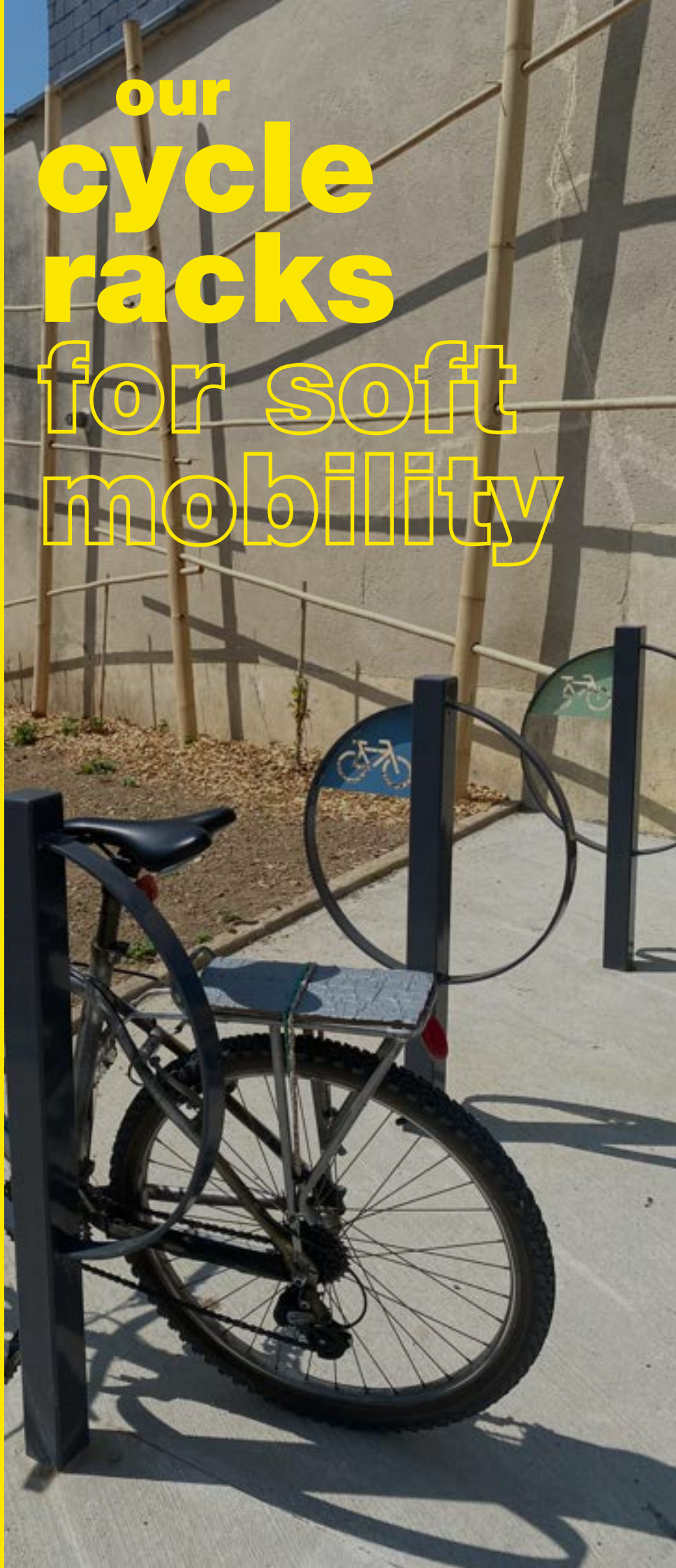



Tigery (FR)

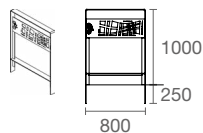

## A-LINÉA cycle rack

### Materials and finishes:

- Painted steel structure

### Attachment:

- Embed in ground or place on base plate



Scan the QR code  
for more information and  
technical data sheet

### View the other products in the A-LINÉA range:

- urban garden p. 30
- planter p. 66
- bench p. 81
- backless bench p. 81
- standing seat p. 81
- barrier p. 100
- bollard p. 100



Cosne-Cours-sur-Loire (FR)

## PASTEL cycle rack

### Materials and finishes:

- Painted steel structure

### Attachment:

- Embed in ground or place on base plate



Scan the QR code  
for more information and  
technical data sheet

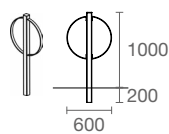

### View the other products in the PASTEL range:

- planter p. 62
- bench p. 77
- backless bench p. 77
- circular bench p. 77
- chair p. 77
- table p. 77
- bin p. 87
- barrier p. 98
- bollard p. 98



## C-NATURA cycle rack



- **Materials and finishes:**
  - Painted steel structure
- **Attachment:**
  - Embed in ground or place on base plate



Scan the QR code for more information and technical data sheet



## DUALIS cycle rack



- **Materials and finishes:**
  - Painted steel structure
- **Attachment:**
  - Embed in ground or place on base plate



Scan the QR code for more information and technical data sheet



## HEDERA cycle rack



- **Materials and finishes:**
  - Painted steel structure
- **Attachment:**
  - Embed in ground or place on base plate



Scan the QR code for more information and technical data sheet



## ORIGAMI cycle rack



- **Materials and finishes:**
  - Painted steel structure
- **Attachment:**
  - Embed in ground or place on base plate



Scan the QR code for more information and technical data sheet



Les Ponts-de-Cé (FR)

## SYNERGIE cycle rack



- **Materials and finishes:**
  - Painted steel structure
- **Attachment:**
  - Embed in ground or place on base plate



Scan the QR code for more information and technical data sheet



## SQUARE cycle rack



- **Materials and finishes:**
  - Painted steel structure
- **Attachment:**
  - Embed in ground or place on base plate



Scan the QR code for more information and technical data sheet



# our barriers, posts and bollards: mini floral installations



## ■ our selection

### SYNERGIE

p. 96

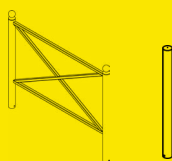

### HEDERA

p. 97

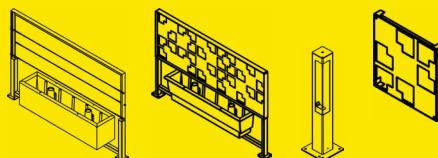

### DUALIS

p. 98

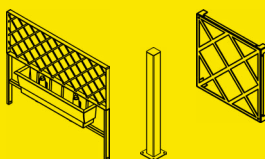

### PASTEL

p. 98

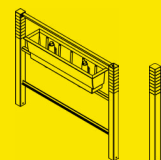

### C-NATURA

p. 99

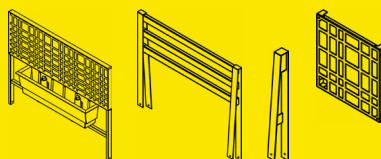

### A-LINÉA

p. 100

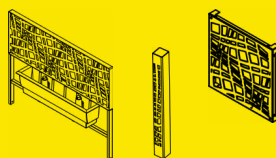

### ORIGAMI

p. 100

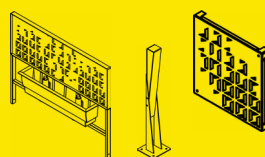

### SQUARE

p. 101

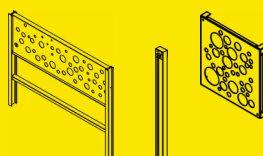

# SYNERGIE

range



Dugny-sur-Meuse (FR)

## classic barrier



0.2 m<sup>2</sup>

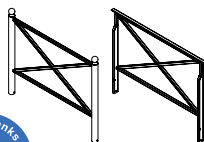

### Materials and finishes:

- Painted steel structure
- Round or square posts

### Attachment:

- Embed in ground, place on base plate or sleeve

### Option:

- Central motif



Scan the QR code for more information and the technical data sheet

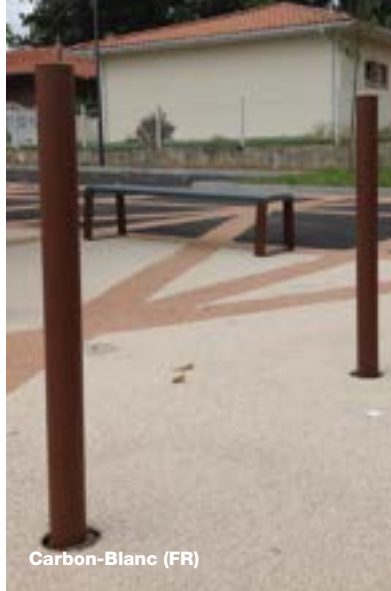

Carbon-Blanc (FR)

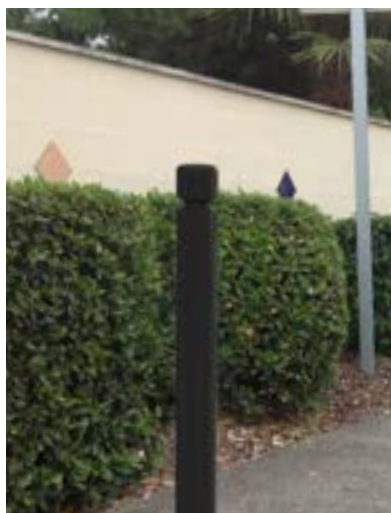

## bollard

### Materials and finishes:

- Painted steel structure

### Attachment:

- Embed in ground, place on base plate or sleeve

### Option:

- PRM



Scan the QR code for more information and the technical data sheet

### View the other products in the SYNERGIE range:

- planter p. 58
- bench p. 78
- backless bench p. 78
- chair p. 78
- table p. 78
- sun lounger p. 78
- cycle rack p. 93



Dugny-sur-Meuse (FR)





Batz-sur-Mer (FR)

### floral barrier



0.2 m<sup>2</sup>



■ **Materials and finishes:**

- Painted steel structure
- Removable flowerbox made of recycled PE
- Stainless steel wires

■ **Attachment:**

- Embed in ground, place on base plate or sleeve



Scan the QR code for more information and the technical data sheet



### floral barrier with trellis



0.2 m<sup>2</sup>



■ **Materials and finishes:**

- Painted steel structure
- Removable flowerbox made of recycled PE

■ **Attachment:**

- Embed in ground, place on base plate or sleeve



Scan the QR code for more information and the technical data sheet



# HEDERA

range

a

### post



0.2 m<sup>2</sup>

■ **Materials and finishes:**

- Painted steel structure

■ **Attachment:**

- Embed in ground, place on base plate or sleeve



Scan the QR code for more information and the technical data sheet

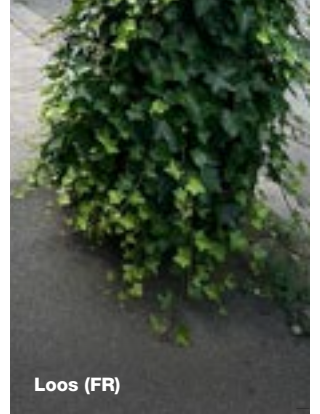

Loos (FR)



### bollard

■ **Materials and finishes:**

- Painted steel structure
- Stainless steel wire for plant support

■ **Attachment:**

- Embed in ground, place on base plate or sleeve



Scan the QR code for more information and the technical data sheet



Miribel (FR)

### trellis

■ **Materials and finishes:**

- Painted steel structure

■ **Attachment:**

- On walls, using attachment hardware (not supplied)



Scan the QR code for more information and to go to the product page



**View the other products in the HEDERA range:**

- planter p. 50
- bench p. 80
- backless bench p. 80
- standing seats p. 80
- bin p. 88
- cycle rack p. 93

# DUALIS

## range



Guichen (FR)

### trellis

- **Materials and finishes:**
  - Painted steel structure
- **Attachment:**
  - On walls, using attachment hardware (not supplied)



Scan the QR code for more information and to go to the product page

#### View the other products in the DUALIS range:

- planter p. 52
- bin p. 86
- cycle rack p. 93



### bollard

- **Materials and finishes:**
  - Painted steel structure
- **Attachment:**
  - Embed in ground, place on base plate or sleeve



Scan the QR code for more information and the technical data sheet

### floral barrier with trellis



0.2 m<sup>2</sup>



- **Materials and finishes:**
  - Painted steel structure
  - Removable flowerbox made of recycled PE
- **Attachment:**
  - Embed in ground, place on base plate or sleeve



Scan the QR code for more information and the technical data sheet



Grandparigny (FR)

### bollard

- **Materials and finishes:**
  - Painted steel structure
- **Attachment:**
  - Embed in ground, place on base plate or sleeve



Scan the QR code for more information and the technical data sheet

### floral barrier



0.2 m<sup>2</sup>



- **Materials and finishes:**
  - Painted steel structure
  - Removable flowerbox made of recycled PE
- **Attachment:**
  - Embed in ground, place on base plate or sleeve



Scan the QR code for more information and the technical data sheet



Dunkerque (FR)

#### View the other products in the PASTEL range:

- planter p. 62
- bench p. 77
- backless bench p. 77
- circular bench p. 77
- chair p. 77
- table p. 77
- bin p. 87
- cycle rack p. 92



## floral barrier with trellis



0.2 m<sup>2</sup>



### Materials and finishes:

- Painted steel structure
- Removable flowerbox made of recycled PE

### Attachment:

- Embed in ground, place on base plate or sleeve



Scan the QR code for more information and the technical data sheet



Teillé (FR)

## bollard

### Materials and finishes:

- Painted steel structure
- Decorative yoke available: Treated bamboo, untreated exotic wood, robinia or larch

### Attachment:

- Embed in ground, place on base plate or sleeve



Scan the QR code for more information and the technical data sheet

# C-NATURA

range

a



## classic barrier

### Materials and finishes:

- Painted steel structure
- Slats: Treated bamboo, untreated exotic wood, robinia or larch

### Attachment:

- Embed in ground, place on base plate or sleeve



Scan the QR code for more information and the technical data sheet

## trellis

### Materials and finishes:

- Painted steel structure

### Attachment:

- On walls, using attachment hardware (not supplied)



Scan the QR code for more information and to go to the product page

### View the other products in the C-NATURA range:

- urban garden p. 32
- planter p. 66
- bench p. 80
- backless bench p. 80
- bin p. 88
- cycle rack p. 93

# A-LINÉA

range



Créteil (FR)

## floral barrier with trellis

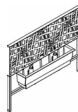

### Materials and finishes:

- Painted steel structure
- Removable flowerbox made of recycled PE

### Attachment:

- Embed in ground, place on base plate or sleeve



Scan the QR code for more information and the technical data sheet



## bollard

### Materials and finishes:

- Painted steel structure

### Attachment:

- Embed in ground, place on base plate or sleeve



Scan the QR code for more information and the technical data sheet



Cambes-en-Plaine (FR)

## trellis

### Materials and finishes:

- Painted steel structure

### Attachment:

- On walls, using attachment hardware (not supplied)



Scan the QR code for more information and to go to the product page

### View the other products in the A-LINÉA range:

- urban garden p. 30
- planter p. 66
- bench p. 81
- backless bench p. 81
- standing seat p. 81
- bin p. 87
- cycle rack p. 91

# ORIGAMI

range



## trellis

### Materials and finishes:

- Painted steel structure



Scan the QR code for more information and to go to the product page

### View the other products in the ORIGAMI range:

- planter p. 58
- bench p. 82
- backless bench p. 82
- bin p. 88
- cycle rack p. 93



## bollard

### Materials and finishes:

- Painted steel structure

### Attachment:

- Embed in ground, place on base plate or sleeve

### Option:

- PRM



Scan the QR code for more information and the technical data sheet



## floral barrier with trellis



### Materials and finishes:

- Painted steel structure
- Removable flowerbox made of recycled PE

### Attachment:

- Embed in ground, place on base plate or sleeve



Scan the QR code for more information and the technical data sheet

# SQUARE

range

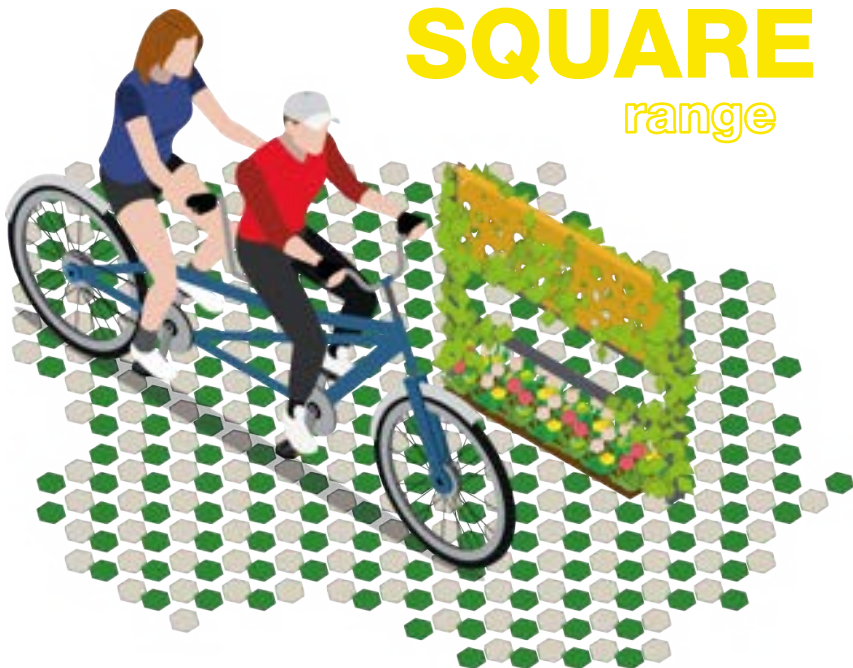

## floral barrier with trellis



0.2 m<sup>2</sup>

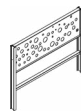

### ■ Attachment:

- Embed in ground, place on base plate or sleeve



Scan the QR code for more information and the technical data sheet

### View the other products in the SQUARE range:

- urban garden p. 34
- planter p. 64
- bench p. 76
- backless bench p. 76
- seat p. 76
- chair p. 76
- bin p. 88
- cycle rack p. 93



## trellis

### ■ Materials and finishes:

- Painted steel structure

### ■ Attachment:

- On walls, using attachment hardware (not supplied)



Scan the QR code for more information and to go to the product page



## bollard

### ■ Materials and finishes:

- Painted steel structure

### ■ Attachment:

- Embed in ground, place on base plate or sleeve

### ■ Option:

- PRM



Scan the QR code for more information and the technical data sheet



# index

## our urban gardens and shade canopies p. 24

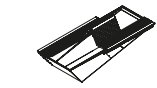
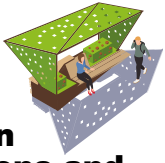

**Prisme**  
p. 26



**Olympe**  
p. 28



**Contrario**  
p. 29



**A-LINÉA**  
p. 30

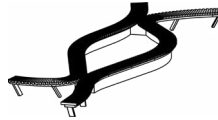

**Edward VII**  
p. 31

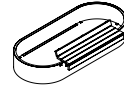

**C-NATURA**  
p. 32

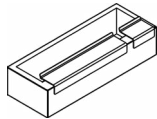

**SQUARE**  
p. 34

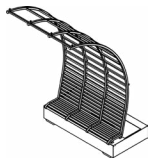

**FreshCity**  
p. 35

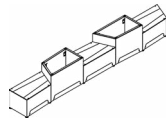

**Oasis**  
p. 36

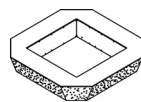

**Mosaique**  
p. 37



**Sustineo**  
p. 38

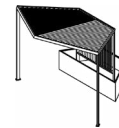

**Équinoxe**  
p. 40

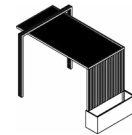

**Hélios**  
p. 42

## our kerbs, edges and bottomless planters p. 44



p. 44

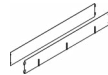

**Edges**  
p. 44



**Bottomless planters**  
p. 45

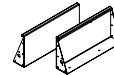
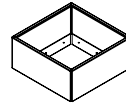
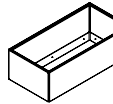

**Kerbs**  
p. 46

## our planters p. 48



p. 48



**HEDERA**  
p. 50



**Classique**  
p. 51



**DUALIS**  
p. 52



**Cube**  
p. 53



**Concave**  
p. 54



**Aéris**  
p. 55



**Mosaique**  
p. 56



**Cléo**  
p. 57



**Asyma**  
p. 58



**SYNERGIE**  
p. 58



**Kesa**  
p. 58



**Origami**  
p. 58



**Pyrou**  
p. 58



**Extrabac**  
p. 60



**Perga**  
p. 61



**PASTEL**  
p. 62



**Patine**  
p. 63



**SQUARE**  
p. 64



**Contrario**  
p. 65



**A-LINÉA**  
p. 66



**Atempo**  
p. 66



**C-NATURA**  
p. 66



**Éole**  
p. 66



**Octogone**  
p. 66



**Extravase and half-Extravase**  
p. 69



**Gal'B**  
p. 70



**Saphir**  
p. 71



**Vase**  
p. 72



**Amphor**  
p. 73



**Pila**  
p. 73



**Quadri**  
p. 73



**Rectiligne**  
p. 73



**our seats**  
p. 74

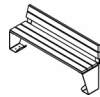

**Bench**



**Backless bench**

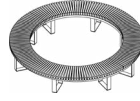

**Circular backless bench**



**Chair**



**Sun lounger**



**Standing seat**

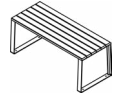

**Table**

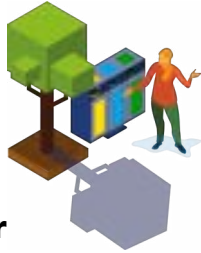

**our bins and composters**

p. 83



**SYNERGIE**  
p. 85

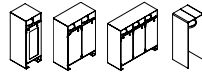

**DUALIS**  
p. 86



**A-LINÉA**  
p. 87



**PASTEL**  
p. 88



**HEDERA**  
p. 89



**C-NATURA**  
p. 89



**ORIGAMI**  
p. 89



**SQUARE**  
p. 89



**Idylle composter**  
p. 90

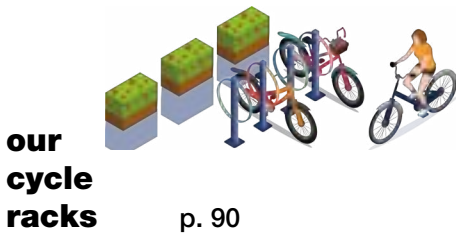

**our cycle racks**  
p. 90

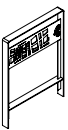

**A-LINÉA**  
p. 91



**PASTEL**  
p. 92



**C-NATURA**  
p. 93



**DUALIS**  
p. 93



**HEDERA**  
p. 93



**ORIGAMI**  
p. 93



**SYNERGIE**  
p. 93

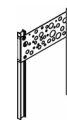

**SQUARE**  
p. 93



**bollards, barriers and mini floral installations**  
p. 94



**Bollard**

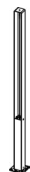

**Post**



**Classic barrier**



**Floral barrier**



**Trellis**

# materials library

## metals and finishes

### STEEL

Available colours with RAL or AkzoNobel reference.

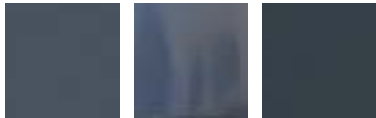

**Steel** is an alloy that contains iron and carbon. It is primarily known for being highly robust. It must be treated before a finish is applied. Available finishes: **grainy powder-coated (sandblasted), gloss or matte.**

### STAINLESS STEEL



**Stainless steel** is an alloy that contains iron, chromium and carbon. It is primarily known for being particularly resistant to corrosion. Available finishes: **brushed, mirror polish.**

### CORTEN STEEL\*



**Corten steel** is an alloy that contains copper, chromium, nickel-molybdenum and phosphorus. It is a natural material with a protective layer known as a patina, with different hues of brown over 18 months before it takes its final colour.

Throughout the process, light and temperature can cause colour changes. Available finishes: **sandblasted** (to accelerate the patina), **activated and sandblasted** (for a product with a patina-look overall), and activated, sandblasted and stabilised (to stop the patina and not stain the ground). There are two techniques for this last finish: the product is either stabilised naturally (**sandblasted, activated and naturally stabilised**), in which case the process lasts around 4 months (with steel painted with the sandblasted Mars 2525 finish an alternative) OR the product is varnished with a matte finish and fired in a furnace (**sandblasted, activated and stabilised (matte)**), with steel painted with RAL 8017 an alternative.

### ALUMINIUM

Available colours with RAL or AkzoNobel reference.

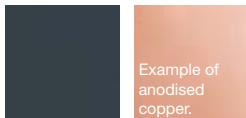

**Aluminium** is a lightweight material that is highly resistant to corrosion. It is also highly malleable, making it ideal for curves or various creative shapes. Available finishes: **powder-coated (grainy, glossy, matte), brushed, anodised (glossy or satin) or polished and anodised.**

### ZINC\*

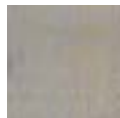

**Zinc** is known for being highly resistant to corrosion. Our zinc products come as panels riveted onto a galvanised steel assembly to optimise costs. Available finish: **pre-patinated.**

\* Tubes cannot be made using these materials

**seats**

**TREATED BAMBOO**

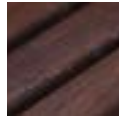

**UNTREATED EXOTIC WOOD**



**UNTREATED ROBINIA**



**UNTREATED LARCH**



Options: wood stain, paint, wood saturator

**RECYCLED PLASTIC**



**COLOURS OF RECYCLABLE PLASTIC FOR FLOWERPOTS**



*\*Textured colours, additional cost*

**DUALIS RANGE WOOD STAINS AND PANELS**

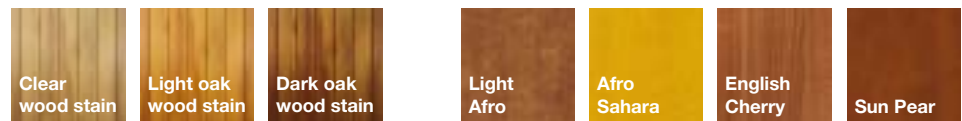

**PASTEL RANGE COLOURS**

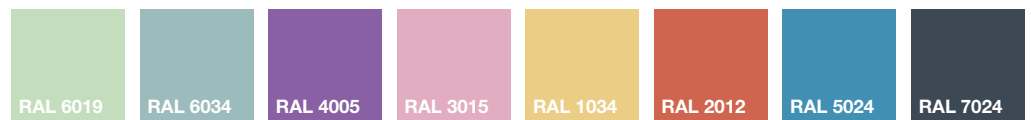

# ATECH backs the French AGEC law (Anti-Waste Law for a Circular Economy Law)



Article 58 of this law sets new targets for municipalities from July 2024 on. Whenever street furniture is purchased now, 5% of the annual amount (excluding taxes) of public-sector contracts must go to upcycling or reuse and 20% to furniture made of recycled materials. This percentage will change over the years, as seen in the chart below. This is also true for waste collection equipment.

## Change in annual targets in %, annual amount of public-sector contracts excl. taxes:

### Category 10: Street furniture



### Category 11: Waste collection equipment



- Upcycled or reused items
  - FreshCity shade canopy (see p. 35) wood taken from former window frames
  - Idylle composter (see p. 89) wood taken from former window frames
- Items with recycled materials
  - Flowerboxes and hanging baskets (see flowering leaflet, scan the QR code on the page opposite) made from 30% oyster waste
  - Planting liners (see p. 67) made with 100% recycled plastic
  - Slats for seats (see p. 104) made with 100% household waste



Urban garden with seat on corner, visible gussets, untreated Corten steel, and recycled plastic slats



## Give your furniture a new lease of life

**Does your steel or aluminium furniture need refreshing?** ATECH can give your steel or aluminium products a new look thanks to repurposing or upcycling. If you have orangery planters that need a fresh lick of paint, or panels that have seen better days, we can collect them and give them a new look. Not only will you observe France's AGEC law, you'll also save money by reusing your furniture. **It's a great way to spread the word about sustainability to others!**

Contact your local ATECH salesperson to discuss options.



## ATECH records your plastic waste and reduces your carbon footprint

**Do you want to get rid of your old plastic pots, flowerboxes and hanging baskets without affecting your carbon footprint?**

ATECH can collect and recycle them. To do so, please make sure they are clean and empty and wrap them on pallets. Contact us for more information.

# We come to you



■ **ATECH SAS**  
 ZI de l'Appentière  
 49280 Mazières-en-Mauges  
 FRANCE  
 Tel. +33 (0)2 41 58 57 13  
 Email: [info@atech-sas.com](mailto:info@atech-sas.com)  
[www.atech-sas.com](http://www.atech-sas.com)

**Corsica, French overseas territories,  
international operations, including Monaco**

■ **Sarah Pineau Derouet**  
 Mobile: +33 (0)6 07 81 48 22  
 Email: [sarahpineauderouet@atech-sas.com](mailto:sarahpineauderouet@atech-sas.com)

## **DACH Countries**

■ **Roxanne Lochard**  
 Mobile: +49 (0)174 858 1054  
 Email: [roxannelochard@atech-sas.com](mailto:roxannelochard@atech-sas.com)

**Scan this QR code  
 to view our  
 flowering leaflet:**



**atech**

[www.atech-sas.com](http://www.atech-sas.com)