



atech

ATECH, DISTRIBUTEUR EXCLUSIF FRANCE DE LA MARQUE GOVAPLAST STREET

Govaplast est un fabricant de mobilier urbain en plastique recyclé, qui s'attache à rester à la pointe de l'innovation en matière de développement de produits, de design et de processus de fabrication. L'entreprise adapte en permanence ses produits aux nouvelles exigences du marché afin de répondre aux besoins de ses clients.

La protection de l'environnement constitue depuis toujours une priorité majeure pour Govaplast. L'entreprise joue un rôle actif dans l'ensemble du processus de recyclage et contribue concrètement à la préservation de la planète. Dans

cette optique, Govaplast applique la philosophie cradle to cradle, utilise des matières recyclées et conçoit des produits finis entièrement recyclables à 100 %.

L'usine Govaplast fonctionne avec de l'énergie « verte » et utilise un système de refroidissement en circuit fermé, réduisant ainsi son empreinte écologique.

Le processus de production original, associé à l'utilisation de matières premières de haute qualité, permet de proposer des produits haut de gamme fabriqués à partir de 100 % de plastiques recyclés (PE et PP).



100%
RECYCABLE



315 millions
de bouteilles
**PLASTIQUES
RECYCLÉES**
l'année dernière



14 400 km
PROFILÉS
produits
EN 1 AN



**PP - LDPE
& HDPE**
pour des produits
ROBUSTES



Résistant aux chocs



Texture naturelle



Facile à travailler



Coloré dans la masse



Sans éclardes



Qualité constante



Antidérapant



Non absorbant



Garantie de 10 ans
sur nos profilés



Élimination facile des rayures



Sans entretien



Flexible



Profilé plein



8 couleurs



Résistant aux UV



Testé



Entièrement recyclable



Nombruses dimensions



100% issu de déchets plastiques



Longue durée de vie



Résistant aux intempéries



Imputrescible



Résistant aux graffitis

design
vlaanderen

henry
van de
velde
labels
/2008



OYAM ECODESIGN
AWARD PRO '08

Canvas

design by CIDES.be

canvas 360



Canvas 180

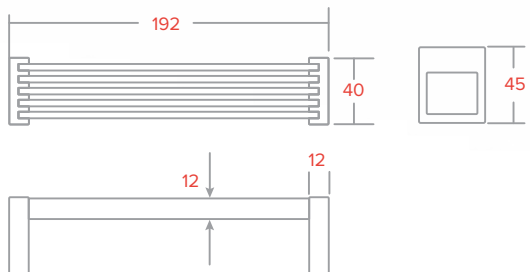

Canvas 360

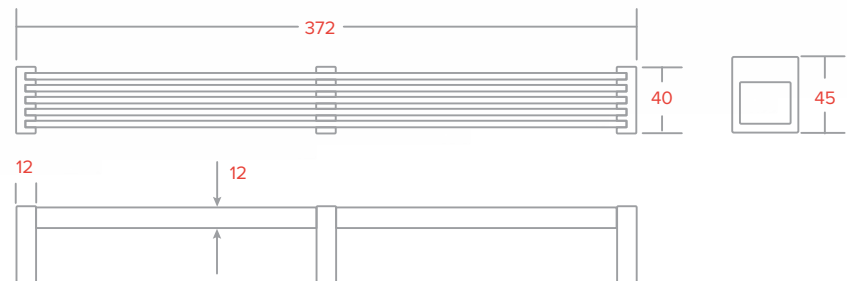



Canvas 30°

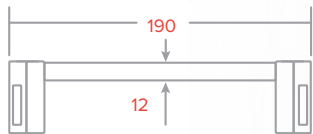
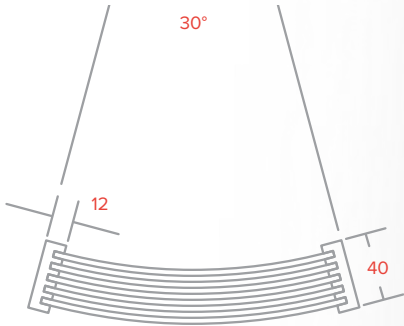



Canvas ML

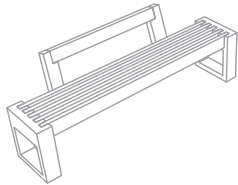

canvas 180 ML

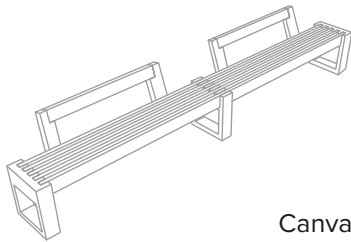

Canvas 360 - 2N

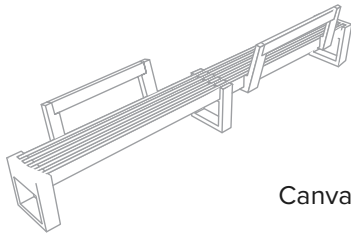

Canvas 360 - 2DL

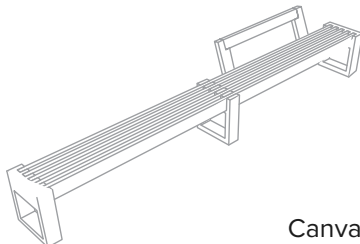

Canvas 360 - 1R



canvas 30°

canvas ML 180

192



Bonn



Bonn ZL

Bonn ML



Bonn ML

Bonn ZL

Bonn ML 360 cm

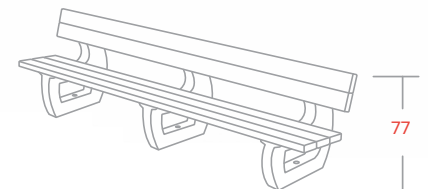
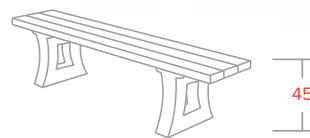
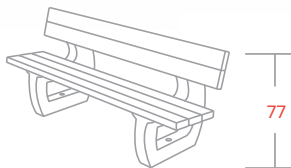



Porto





London



London ML

London T

London ZL



London 4 ML

London ML

London ML 360 cm

London ZL

London T

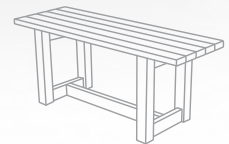
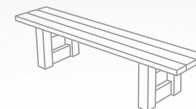
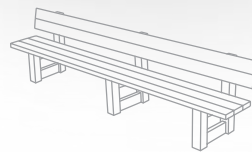
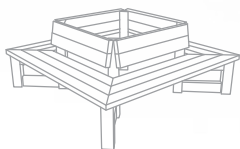



Roma

Table de pique-nique
pour 12 personnes





Oslo

Agora



Oslo

Oslo Junior

Corbeille Agora



Oslo

Oslo Junior  Modèle enfant

Corbeille Agora

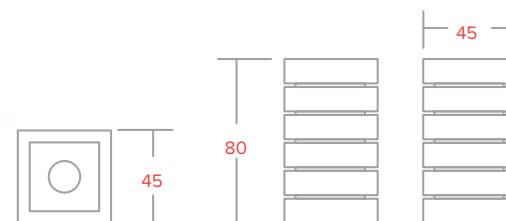
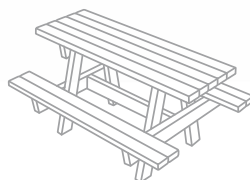
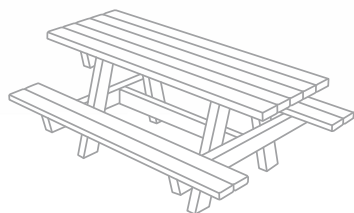



Normandie

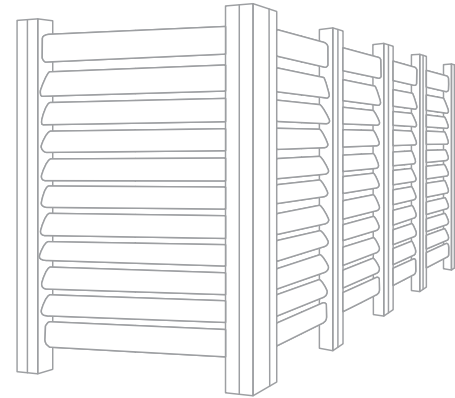

	130	100	130	100
H 120				
H 135				
H 150				
H 180				



Avec pieds prolongés (scellement)
ou système de fixation avec platine

Potelet

Amovible ou non amovible

Les potelets amovibles sont idéaux pour les routes et les parkings qui ferment périodiquement.



Potelet
Fixation fixe

15 X 15 X 140



Potelet
Fixation fixe

15 X 15 X 140



Potelet
Amovible

15 X 15 X 140

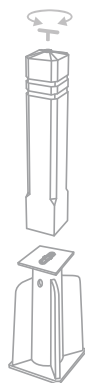

Potelet
Fixation fixe

10 X 10 X 140



Prisma

Govaplast lance un nouveau produit pionnier : du mobilier urbain intégrant des éléments imprimés en 3D. Pour cette innovation, l'entreprise utilise pour la première fois du plastique recyclé issu de réfrigérateurs mis au rebut. Les granulés obtenus à partir de ces matériaux recyclés offrent des propriétés optimales pour cette application. La solidité des couleurs est garantie par l'ajout de carbone au mélange d'impression 3D, une combinaison unique développée par Govaplast, assurant un noir profond et durable. Les bancs sont entièrement modulables et, grâce aux planches Govaplast, les possibilités d'aménagement sont illimitées. Un produit 100 % circulaire.

| Exemple de configuration



194 x 36,5 x 46 cm

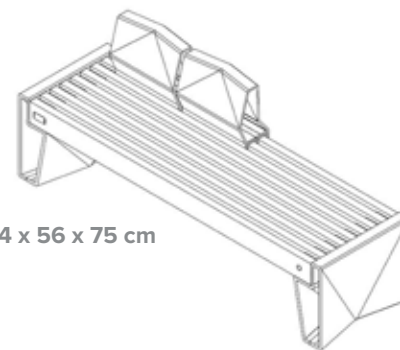

194 x 56 x 75 cm

| Piètement et dossier

■ Noir

| Lames

■ Beige

■ Mineral Grey

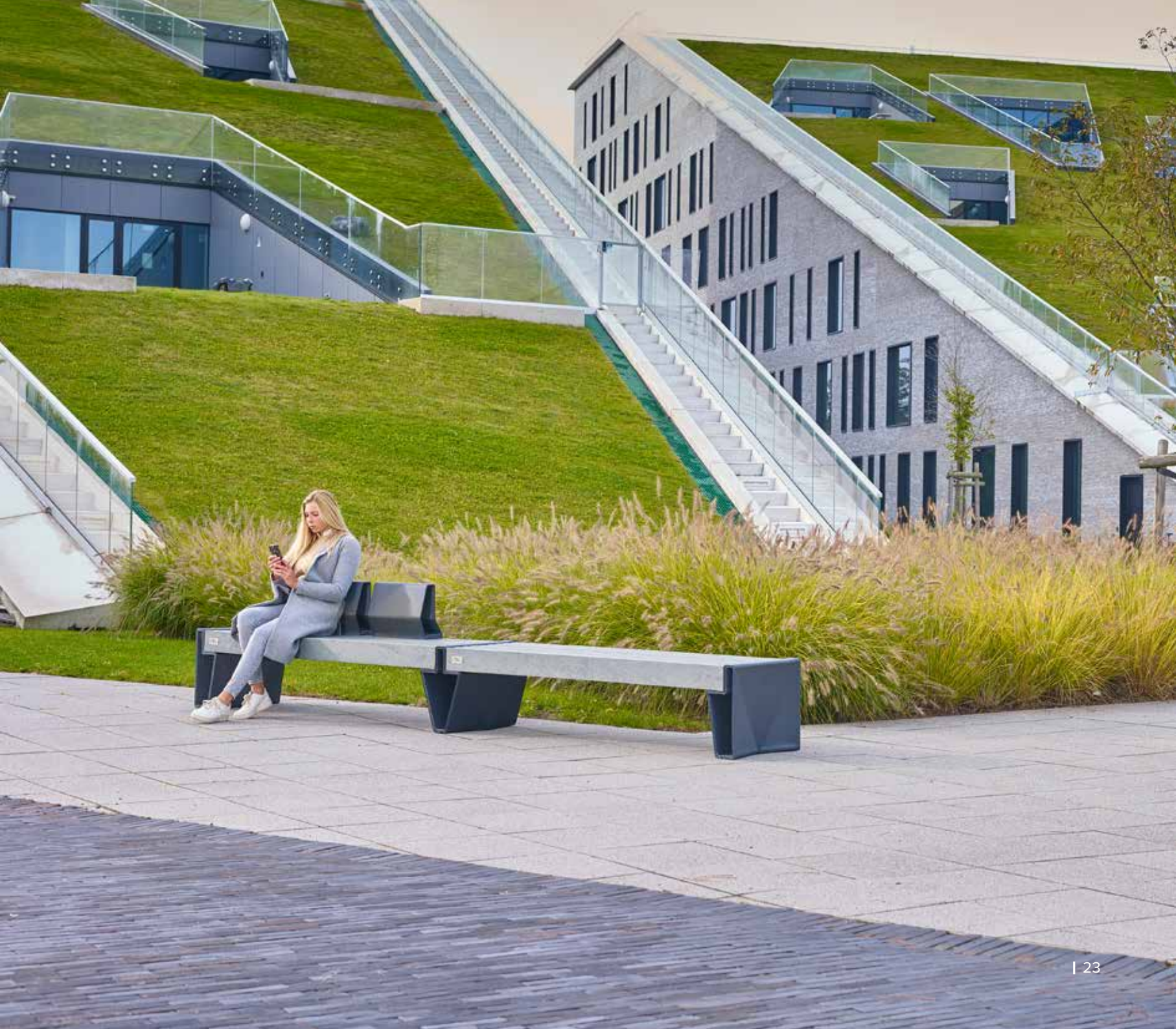

atech

ATECH SAS | 155 rue de l'Appentière
49280 Mazières-en-Mauges | FRANCE
Tél. +33 (0)2 41 58 57 13
Mail : info@atech-sas.com
www.atech-sas.com

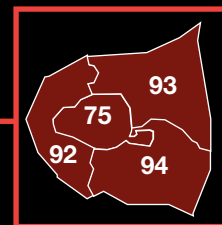

Fabrice POINT

Port. 06 84 83 13 72
Mail : fabricepoint@atech-sas.com

Nicolas D'ALFONSO

Port. 06 84 83 13 73
Mail : nicolasdalfonso@atech-sas.com

Jean-Paul CANONACO

Port. 07 60 24 73 65
Mail : jeanpaulcanonaco@atech-sas.com

Patricia BÉCEL-LÉONARD

Port. 06 08 07 08 14
Mail : patriciabecelleonard@gmail.com

Jean-Charles REY

Port. 06 30 27 87 32
Mail : jeancharlesrey@atech-sas.com

DOM-TOM, international dont Monaco

Sarah PINEAU DEROUET

Port. +33 (0)6 07 81 48 22
Mail : sarahpineauderouet@atech-sas.com

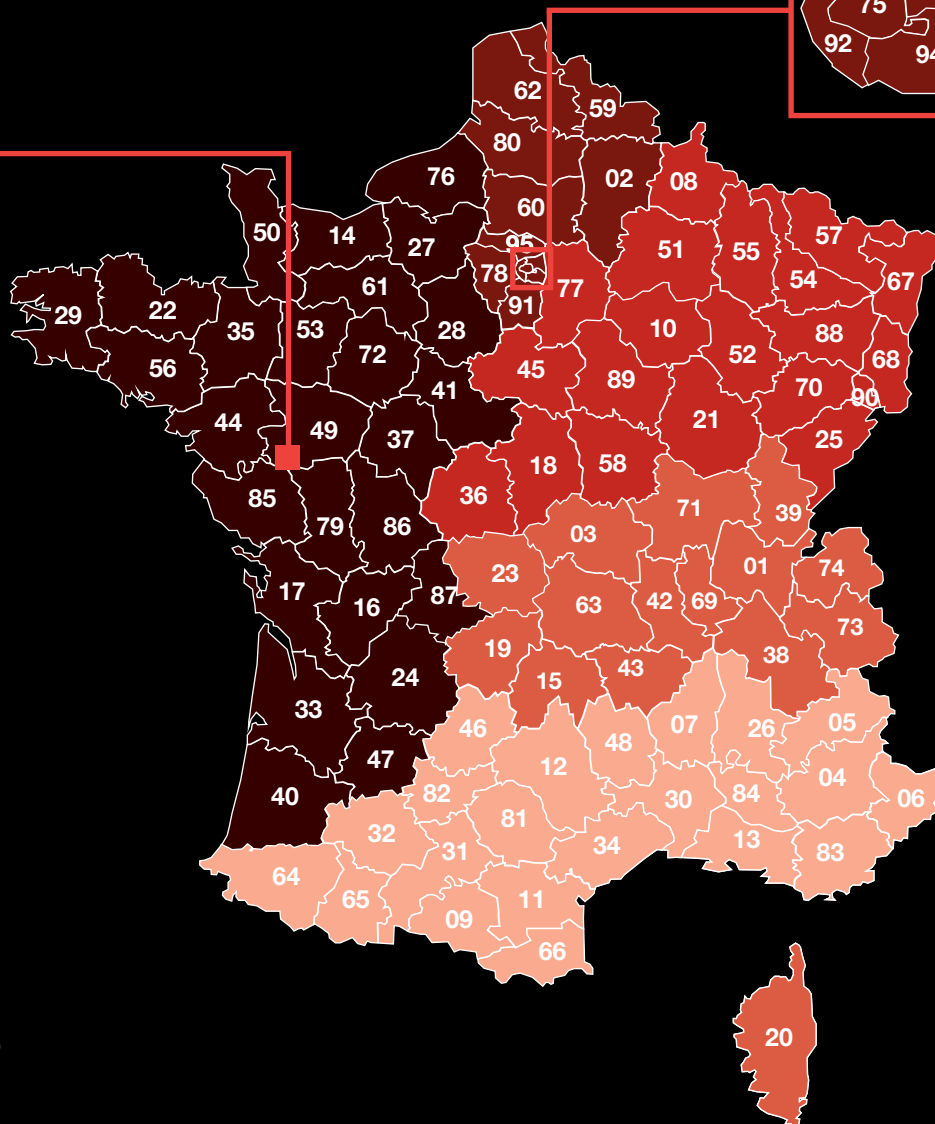

MARTINIQUE



GUYANE



MAYOTTE



RÉUNION



GUADELOUPE

