

Voir la fiche technique du jardin urbain Prisme p.2

Discover the technical sheet of the urban garden Prisme p.5

entdecken Sie das technisches abeitslatt der stadtgarten Prisme p.8

atech

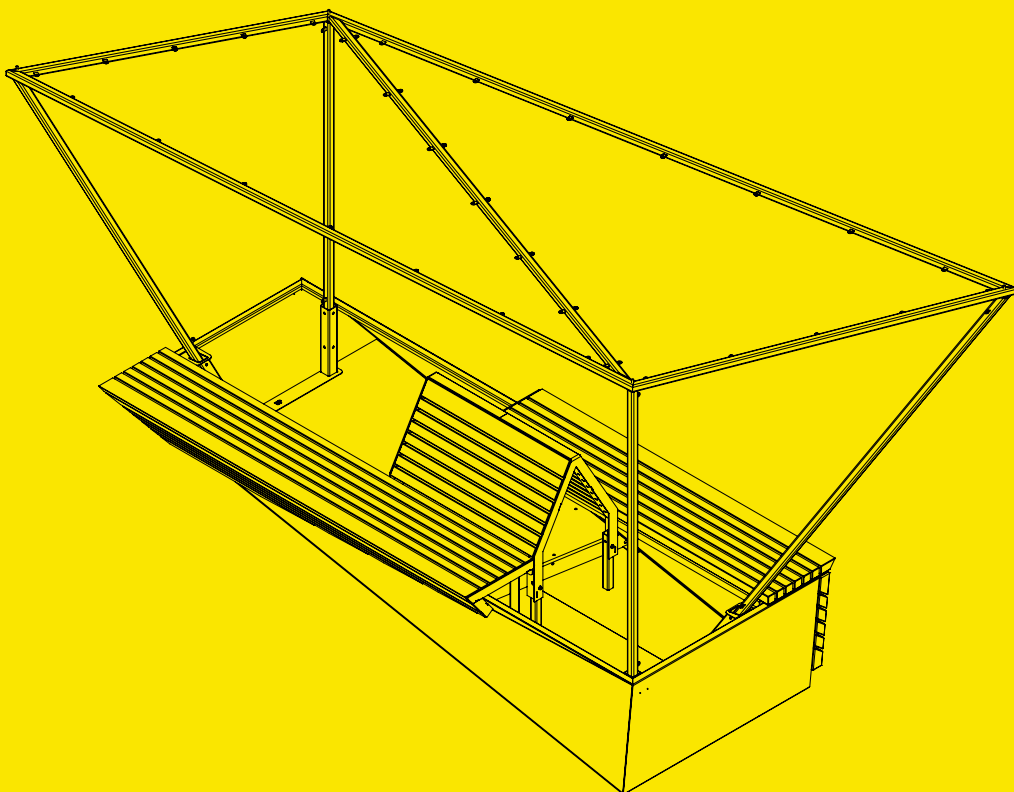

JARDIN URBAIN Prisme

■ modèle déposé



min : 2.2m²
max : 15.1m²

Contact :

info@atech-sas.com

02 41 58 57 13

www.atech-sas.com



aller sur
la page produit

demander
un devis



Prisme n°5 - Option ombrière structure pour grimpants

atech

Matériaux et finitions :

- Structure acier ép. 3 mm, traitement anti-corrosion, thermolaquage coloris RAL ou AkzoNobel au choix
- Passage de fourches
- Assise et dossier :

Bois exotique brut, Mélèze brut

- Réserve d'eau avec trop-plein
- _ avec colonnes de capillarité : tube de remplissage, réserve d'eau (copolight, géotextile anti-racinaire) avec trop plein

Fixation :

- À poser au sol

Variante :

- Structure en acier corten

Options :

- Capteur Tranquileau (2 sondes)
- Uniquement pour les n°4 et 5, ombrière par :
 - _ voile d'ombrage pour micro-aération
 - _ structure inox (maille et filins) pour une végétalisation dense
 - _ maille inox avec végétal développé pour une ombre rafraîchie (sur demande) végétalisation (fournie sur demande)

NOTRE RÉSERVE D'EAU DISPONIBLE EN OPTION AVEC LES JARDINS URBAINS ET LES BACS SOUDÉS

Permet de : réduire la fréquence d'arrosage, éviter les tournées inutiles et économiser l'eau

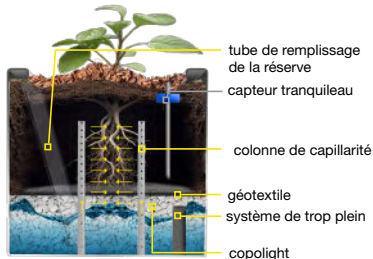

MODULE - BAC À PLANTES

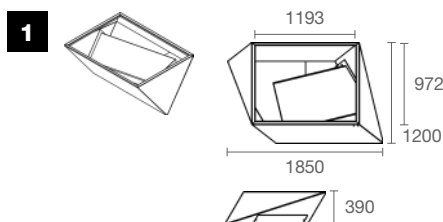

MODULE - BANQUETTE

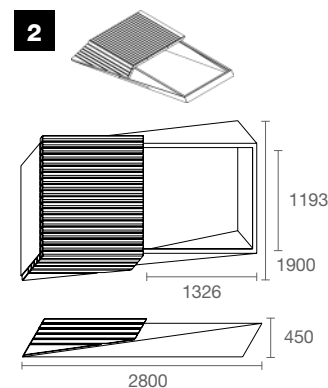

MODULE - BANC

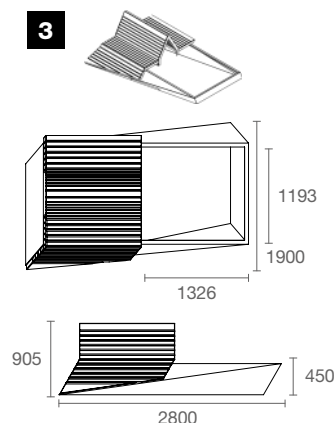

10 mm = 1m

Module	1	2	3	4	5	4	5	option ombrière
Poids structure (Kg)	100	300	600	600	920			
Surface végétalisée potentielle (M ²)	2.2	2.2	4.4	4.4	15.1			
Vol. substrat (L)	434	1240	1525	1525	1250			
Vol. eau (L)	70	270	400	400	425			

JARDIN URBAIN
Prisme

■ modèle déposé



min : 2.2m²
max : 15.1m²

Contact :

info@atech-sas.com

02 41 58 57 13

www.atech-sas.com



aller sur
la page produit

demander
un devis



Prisme n°5 - Option ombrière structure pour grimpants

atech

10 mm = 1m

MODULE - BANQUETTE

4

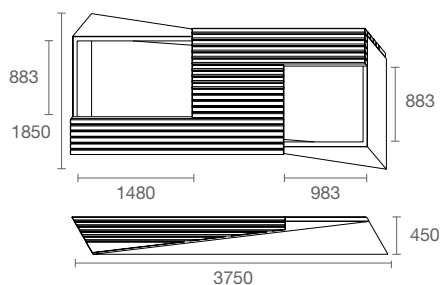
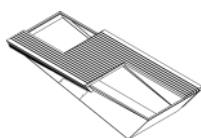

MODULE - BANC

5

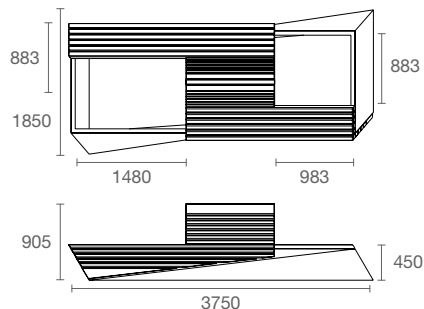
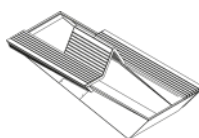

OPTION OMBRIÈRE

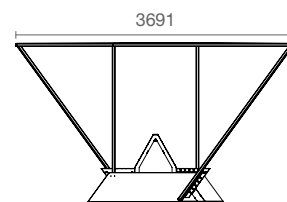
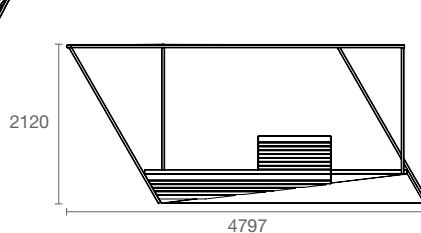
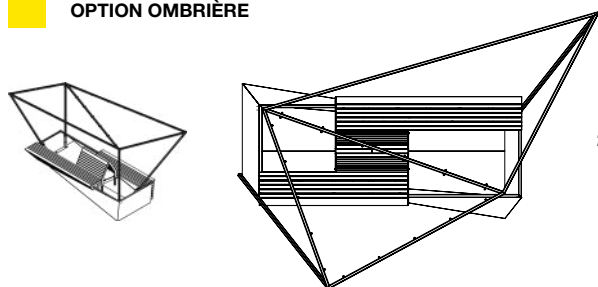

Aménagement	1	2	3	4	5	4	5	option ombrière
Poids structure (Kg)	100	300	600	600	920			
Surface végétalisée potentielle (M ²)	2.2	2.2	4.4	4.4	15.1			
Vol. substrat (L)	434	1240	1525	1525	1250			
Vol. eau (L)	70	270	400	400	425			



**JARDIN URBAIN
Prisme**

■ modèle déposé



min : 2.2m²
max : 15.1m²

Contact :

info@atech-sas.com
02 41 58 57 13

www.atech-sas.com



aller sur
la page produit

demander
un devis



Jardin urbain Prisme - 2-5-1 - Luxembourg

COMPOSEZ VOTRE AMÉNAGEMENT

10 mm = 1m

A 1-5-1

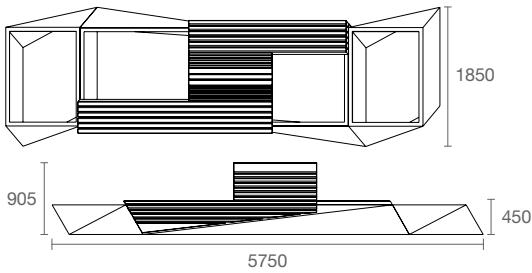

B 3-5

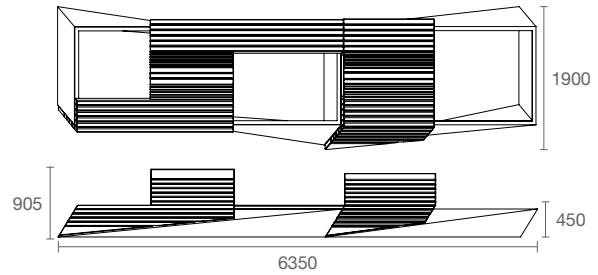
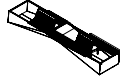

C 1-4-2

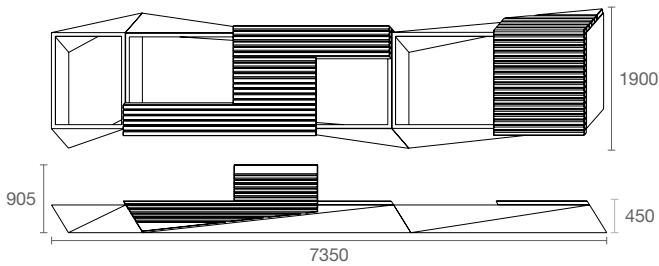

D 5-4

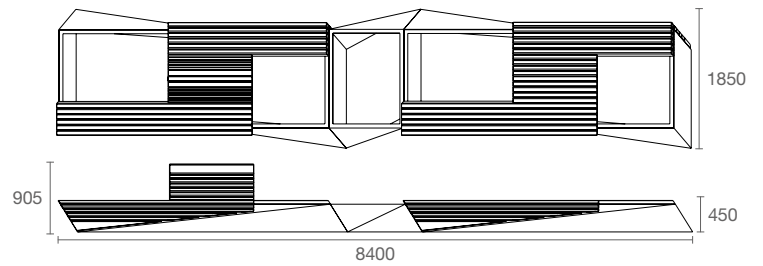

PRISME
urban garden

■ registered design



min: 2.2m²
max: 15.1m²

Contact:

info@atech-sas.com
(+33) 2 41 58 57 13

www.atech-sas.com



go to the
product page

ask for a quote



Prisme n°5 - Stainless steel mesh for dense vegetation



Materials and finishes:

- 3 mm thick corten steel or steel structure, powder coated in RAL or AkzoNobel color of your choice
- Fork pockets
- Seat and back in treated Bamboo, raw Larch (Ask for a quote)

- Water Reserve with overflow system
- with capillarity columns : filling tube, water reserve (geotextile and copolight), with overflow system

Fixing:

- To put on the ground

Variant:

- Corten steel structure

Options:

- Tranquileau sensor (2 sensors)
- Only for the numbers 4 and 5, shading by :
 - Shade sail for micro-aeration
 - Stainless steel mesh for dense vegetation
 - Stainless steel mesh with developed vegetation for cool shade (on request)

OUR WATER RESERVE AVAILABLE IN OPTION WITH URBAN GARDENS AND WELDED PLANTERS

Allows you to: reduce watering frequency, avoid unnecessary rounds and save water

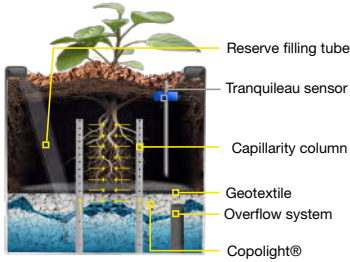

MODULE - PLANTER

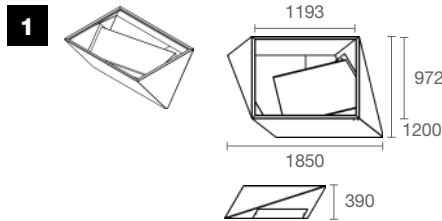

MODULE - BACKLESS SEAT

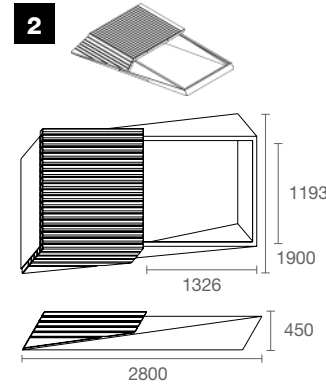

MODULE - BENCH

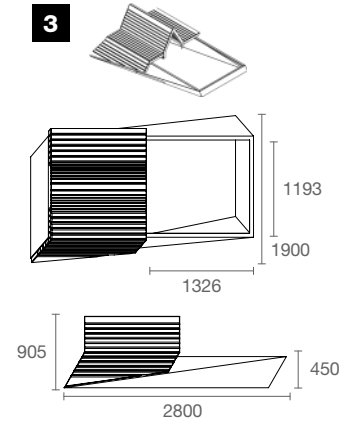

10 mm = 1m

Module	1	2 3	4 5	4 5 shade option
Weight structure (Kg)	100	300	600	920
Potentially vegetated area (M ²)	2.2	2.2	4.4	15.1
Substrate vol. (L)	434	1240	1525	1250
Water vol. (L)	70	270	400	425

PRISME
urban garden

■ registered design



min: 2.2m²
max: 15.1m²

Contact:

info@atech-sas.com
(+33) 2 41 58 57 13

www.atech-sas.com



go to the
product page

ask for a quote



Urban garden Prisme - 2-5-1 - Luxembourg

CREATE YOUR OWN LAYOUT

10 mm = 1m

A 1-5-1

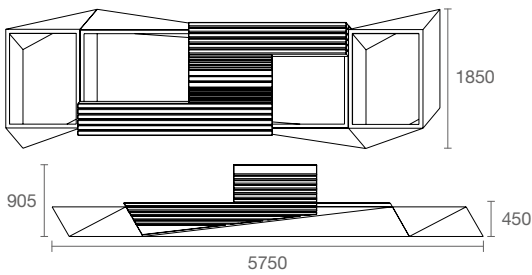
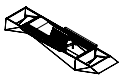

B 3-5

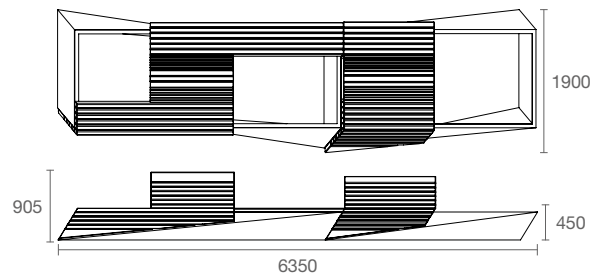
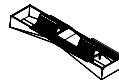

C 1-4-2

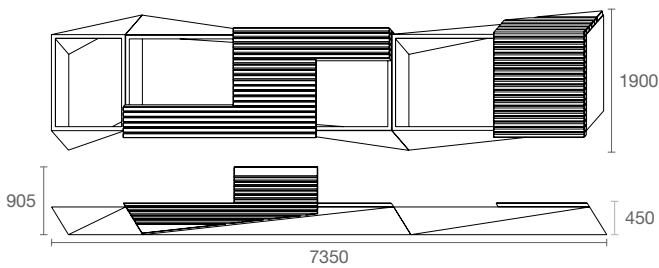

D 5-4

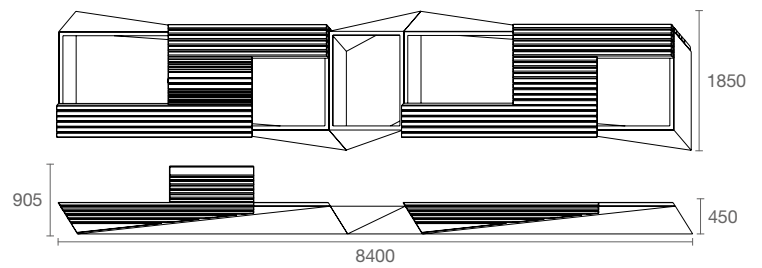

PRISME
urban garden

■ registered design



min: 2.2m²
max: 15.1m²

Contact:

info@atech-sas.com
(+33) 2 41 58 57 13

www.atech-sas.com



go to the
product page

ask for a quote



Prisme n°5 - Shade option by steel mesh for dense vegetation

10 mm = 1m

MODULE - BACKLESS SEAT

4

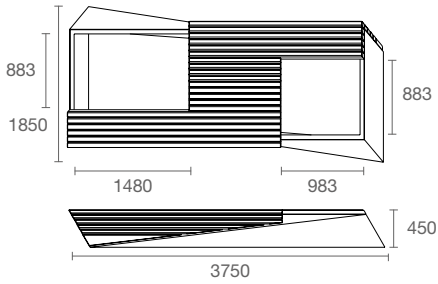
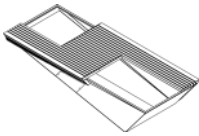

MODULE - BENCH

5

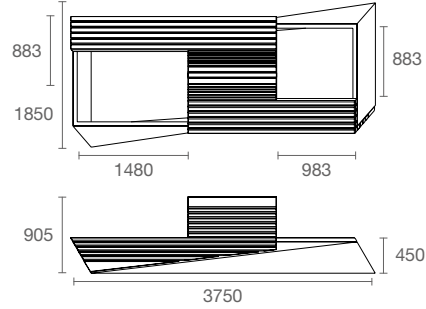
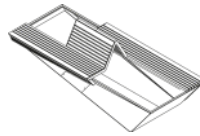

SHADE OPTION

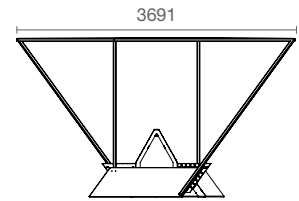
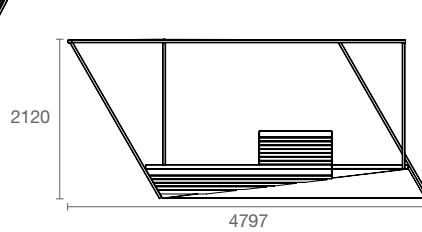
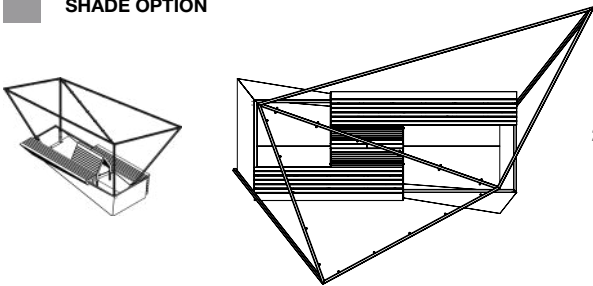

**PRISME
stadtgarten**

■ eingetragenes Design



min: 2.2m²
max: 15.1m²

Contact:

info@atech-sas.com
(+33) 2 41 58 57 13

www.atech-sas.com



**Weiter zur
Produktseite**

**um ein
Angebot bitten**



Prisme n°5 - Edeltahlgewebe für dichte Vegetation

Materialien und Oberflächen:

- Aus Stahl, St. 3 mm, mit Korrosionsschutz behandelt und pulverbeschichtet in RAL- oder AkzoNobel-Farben nach Wahl
- Transpalettierbares System
- Sitz Bohlen aus behandeltem Bambus, roh exotischem Holz, roh Robinie

- Wasserreserve mit Überlaufsystem
- mit Kapillarsäulen : Füllrohr, Wasserreserve (Geotextil und Copolight), mit Überlaufsystem Water Reserve with overflow system

Befestigung:

- Zum Aufstellen auf dem Boden

Options :

- Wassersensoren (2 Sensoren)
- Sitzfläche Lärchenholzleisten roh (Fordern Sie ein Angebot an)
- Schattierungssegel für eine Mikrobelüftung
- Edeltahlnetz für eine dichte Begrünung
- Edeltahlnetz mit gewachsener Vegetation für einen kühlen Schatten (auf Anfrage)

**WASSERSPEICHER FÜR STADTGÄRTEN ODER
VERSCHWEISSTE PFLANZKÜBEL**

Ermöglicht es Ihnen, die Bewässerungshäufigkeit zu reduzieren, unnötige Runden zu vermeiden und Wasser zu sparen

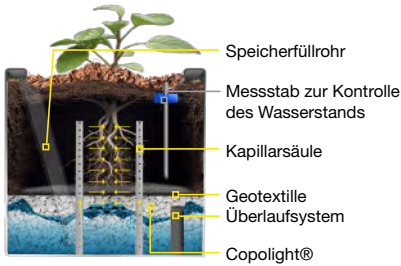

PFLANZKÜBEL

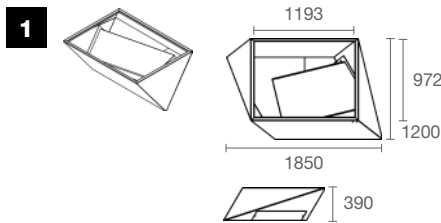

BANK

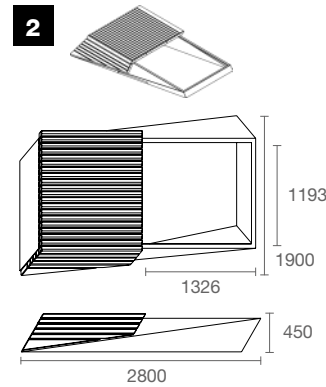

SITZBANK

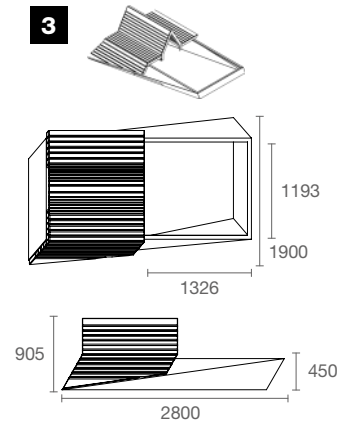

**PRISME
stadtgarten**

■ eingetragenes Design



min: 2.2m²
max: 15.1m²

Contact:

info@atech-sas.com

(+33) 2 41 58 57 13

www.atech-sas.com



**Weiter zur
Produktseite**

**um ein
Angebot bitten**



Stadtgarten Prisme - 2-5-1 - Luxemburg

CREATE YOUR OWN LAYOUT

A 1-5-1

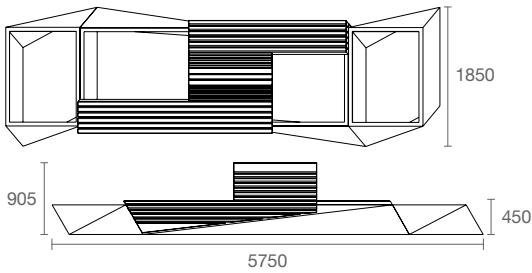
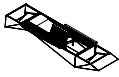

B 3-5

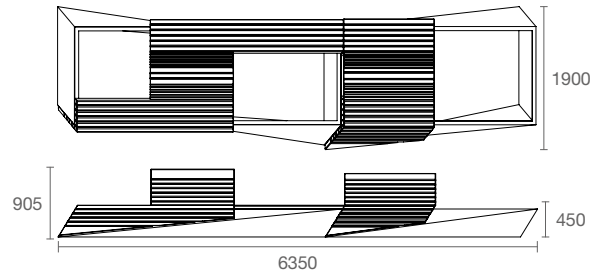
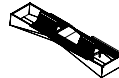

C 1-4-2

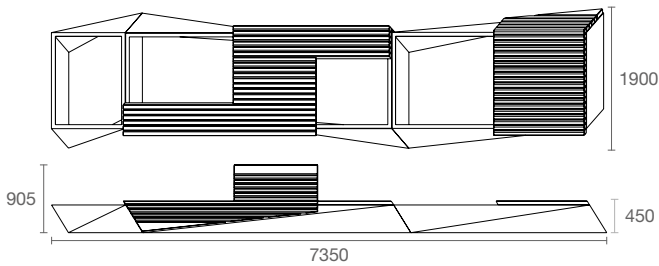

D 5-4

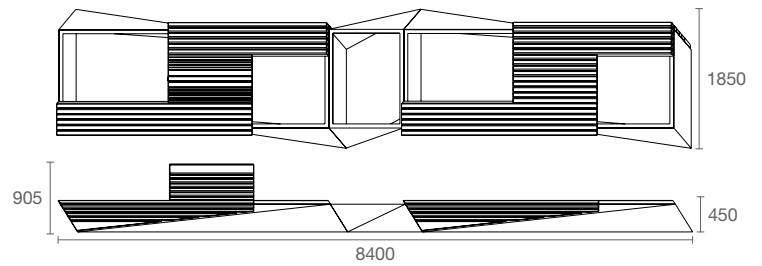

**PRISME
stadtgarten**

■ eingetragenes Design



min: 2.2m²
max: 15.1m²

Contact:

info@atech-sas.com
(+33) 2 41 58 57 13

www.atech-sas.com



**Weiter zur
Produktseite**

**um ein
Angebot bitten**



Prisme n°5 - Edelstahlnetz für eine dichte Begrünung

BANK

4

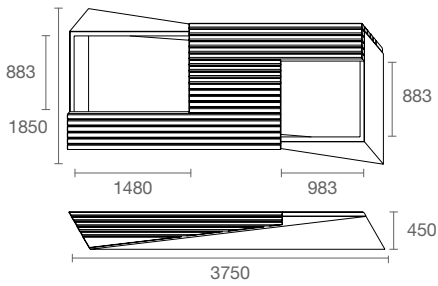
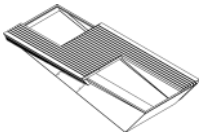

SITZBANK

5

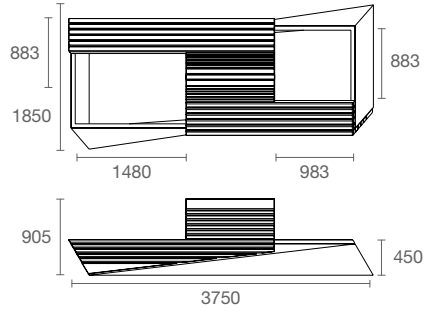
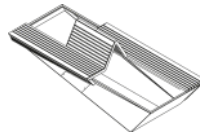

EDELSTAHLNETZ FÜR EINE DICHT BEGRÜNUNG

